



CUCINE  
**LUBE**

GRUPPO LUBE

**CREO**  
KITCHENS



gioielli d'acciaio

un marchio italiano che produce solo in Italia



SELEZIONE 2022

# INDICE

- 2 ••• CM SpA dal 1967
- 3 ••• Caratteristiche del prodotto
- 4 ••• Acciaio INOX AISI 304-18/10
  - Trattamenti PVD
  - Pulizia
- 5 ••• Installazione
  - Informazioni tecniche
- 6 ••• Linea **LUXURYSTYLE**
  - 8 profili
  - 9 finiture
  - pilette
  - 10 indice
- 60 ••• Optionals **LUXURYSTYLE**
- 64 ••• Giada MONOblocco
- 66 ••• Linea **COLORSTYLE**
  - 68 finiture
  - pilette
  - 69 profili
  - indice
- 73 ••• Optionals **COLORSTYLE**
- 74 ••• Linea **CLASSICSTYLE**
  - 76 profili
  - 77 finiture
  - pilette
  - 78 indice
- 107 ••• Optionals **CLASSICSTYLE**
- 109 ••• INDICE Miscelatori
- 110 ••• Miscelatori **HYDRAMIX**
- 116 ••• Miscelatori **ACQUAMIX**
- 131 ••• Miscelatori **EASYMIX**
- 132 ••• Componenti
- 136 ••• Servizio clienti



La capacità di crescere nel tempo, la dinamicità del fare trasformata in progetti ambiziosi.

CM è un'azienda familiare capace di creare in più di 50 anni di attività una storia d'impresa, ponte fra sogni, sacrifici e soddisfazioni.

Forte di investimenti e creatività sempre al passo con i tempi, testimone negli anni di stile e contemporaneità nel mondo dell'arredo cucina.

Portabandiera del Made in Italy in forme e soluzioni innovative, con un marchio ancora oggi orgoglioso di saper produrre solo in Italia.

Ascoltare l'esigenza di mercato, interpretare i cambiamenti e trovare risposte, questo la rende riconoscibile e la onora di collaborare con le più distinte aziende del settore, non tralasciando chi nella piccola industria dell'artigianato locale e nazionale sa sempre apprezzare ed esporre prodotti di qualità.

Guardare al futuro è l'impulso naturale che CM ha come attitudine, in un orizzonte di sfide non distoglie lo sguardo al materiale da sempre principio dell'azienda "l'acciaio inox" ma interpreta con l'aiuto di tecnici e collaboratori professionisti lo studio di tecnologie eco-concepite, cosciente di poter contribuire ad un miglioramento sull'impatto ambientale e sociale.

Il pilastro portante del prodotto CM si avvale di un credo fondante basato non solo su "come si realizza" ma si pone, oggi più di ieri, l'obiettivo di trasmetterne l'essenza del "perché".

**L'esperienza di oggi, dal 1967**

# Caratteristiche del prodotto

## TUTTI GLI OGGETTI NASCONO UNICI E CONTINUANO AD ESSERLO.



### ● **Prodotto Certificato garanzia dei materiali**

Il marchio "INOX", rilasciato dal Centro Inox Servizi Srl, contraddistingue il materiale "acciaio inossidabile". L'acciaio inossidabile è una lega che unisce la proprietà di resistenza meccanica, tipica dell'acciaio, ad una elevata resistenza alla corrosione. E' un materiale igienico, atossico, resistente sia alle alte che alle basse temperature, dal raffinato e versatile aspetto estetico ed assolutamente inalterabile nel tempo e di lunga durata.

### ● **Prodotto Italiano**

Dalla progettazione alla produzione, dalla logistica alla vendita, CM persegue il "MADE IN ITALY", da sempre fondamento e valore portante dell'azienda.

### ● **Prodotto di Qualità**

Il concetto di qualità per CM non è "percezione" ma una caratteristica reale del prodotto. Studio e sviluppo dei prodotti soddisfano nel tempo le esigenze della clientela, protraendo collaborazioni autentiche con i maggiori brand del settore.

### ● **Prodotto Riciclabile al 100%**

L'acciaio è un materiale ecosostenibile, può essere riciclato infinite volte senza perdere alcuna delle sue proprietà originarie pertanto il ciclo di vita dell'acciaio è potenzialmente senza fine. Ciò lo rende una vera e propria "risorsa permanente", essenziale per lo sviluppo di un'economia sostenibile.

### ● **Prodotto Igienico adatto al contatto con alimenti**

Elementare ma non scontato nell'ambiente cucina, è avere componenti che non rilascino sostanze nocive. CM si avvale di un materiale come l'acciaio inox Aisi 304 18/10 adatto al contatto con gli alimenti grazie alla sua elevata rimovibilità batterica.

### ● **Prodotto Facile da pulire - sempre lucente**

Il lavello in acciaio inox necessita di pochi ma importanti accorgimenti per rimanere immutato nel tempo. CM consiglia l'utilizzo di un panno morbido esclusivamente con detergenti neutri in caso di sporco leggero o impronte, di spugne di nylon note come "scotch brite" in caso di sporco ostinato.

La storia nel tempo e l'esperienza hanno arricchito il Know-How di CM, inoltre dispone di un parco macchine ben strutturato che spazia dalle presse oleodinamiche, ai laser e ad impianti di alta tecnologia, impiegando una maestria molto professionale con esperienza pluridecennale che consente al realizzo della più ampia gamma di lavelli in acciaio inox esistenti nel mercato.

#### ● **MONOSTAMPO**

Da un unico foglio, grazie all'utilizzo di stampi particolari e complessi, viene ricavato il lavello monostampato.

#### ● **VASCA SALDATA**

Un foglio di lamiera lavorato di stampo diventa involucro, 1 o 2 fogli di lamiera lavorati di stampo diventano vasche, per essere saldati assieme e dare vita al classico lavello saldato.

#### ● **COSTRUITE**

Laser, piegatura e saldatura: modalità costruttiva che dà vita a molteplici misure e forme di lavelli in particolare vasche quadre con raggiature minime e design moderno.



Un lavello CM accende e illumina la cucina che lo accoglie. Il marchio, rilasciato dal Centro Inox, contraddistingue il materiale acciaio inox AISI 304 18/10 che ha la caratteristica principale di non arrugginire se esposto all'aria e all'acqua. L'acciaio inossidabile ha una proprietà che lo rende unico: si autoprottegge. Grazie ai suoi elementi di lega, sulla sua superficie si forma un sottile, trasparente "strato passivo". Se la superficie viene graffiata o subisce altri danni, lo strato passivo molto sottile, composto solo da pochi atomi, istantaneamente si riforma sotto l'azione dell'ossigeno presente nell'aria o nell'acqua. Questo spiega perché l'acciaio inossidabile non richiede alcun rivestimento o altra protezione per rimanere lucido e brillante, anche dopo essere stato usato per decenni.

L'innovativo trattamento fisico PVD (Physical Vapor Deposition) su base inox, conferisce un'esclusiva colorazione migliorando la resistenza a graffi e usura. Le proprietà tecniche acquisite rendono questo materiale di estrema durezza, massima resistenza alla corrosione, inattaccabile da solventi, acidi o alcali e da prodotti anticalcare utilizzati per uso domestico, inalterabile alla luce. Grazie ad innovativi processi produttivi è in grado non solo di inibire la proliferazione di batteri ma anche di eliminarli. Il trattamento PVD è un'evoluzione dei processi di deposizione sotto vuoto, che permette l'ottenimento di film metallici sottili, dalle proprietà innovative sia dal punto di vista estetico che tecnico.

## Pulizia

Il lavello in acciaio inox, necessita di pochi ma importanti accorgimenti per rimanere immutato nel tempo:

- Utilizzare esclusivamente detergenti neutri, stendendoli con un panno morbido o pelle scamosciata, in caso di sporco leggero o impronte, oppure con spugnette di nylon (note come "scotch brite") in caso di sporco più ostinato.
- Risciacquare abbondantemente con acqua pulita.
- Asciugare tempestivamente con panno morbido, seguendo la satinatura.
- Per evitare aloni o tracce di calcare non lasciare appoggiate per lungo tempo le spugne bagnate o altri oggetti che potrebbero creare macchie e togliere lucentezza all'acciaio.
- Soluzioni corrosive, utensili ferrosi (es. forbici) non vanno assolutamente lasciate nella superficie in acciaio.
- Raccomandiamo di non lasciare per lungo tempo a contatto con il lavello cibi acidi o con alta percentuale di sale, se questo dovesse accadere consigliamo di sciacquare abbondantemente.
- E' importante prestare attenzione anche alla qualità dell'acqua, non solo per la quantità di calcare ma, anche per la percentuale di ferro che, qualora sia alta, potrebbe causare la formazione di macchie scure, simili alla ruggine.
- Sugeriamo di pulire settimanalmente con un prodotto cremoso specifico come il "Buffel Inox", raccomandato da CM, applicandolo puro (non diluito) con un panno-carta, seguendo il verso di satinatura.

## Pulizia acciaio con trattamento PVD

I prodotti con trattamento PVD si presentano uniformi nella loro colorazione e tale caratteristica necessita di ulteriori accorgimenti, pertanto si consiglia di seguire le indicazioni date per la pulizia del lavello in acciaio inox, aggiungendo poche ma essenziali accortezze.

Durante le operazioni di manutenzione/pulizia raccomandiamo di evitare tassativamente l'utilizzo di pomice, paglietta d'acciaio, spugnette o panni impregnati di polveri abrasive. In caso di leggero viraggio del colore o di permanenza di macchie calcaree persistenti pulire con panno morbido e aceto; evitare l'utilizzo di qualsiasi altro detergente acido o sintetico contenente cloro, fluoro, acido muriatico, ossigeno o prodotti candeggianti.

## Installazione

### FORATURA PER LA RUBINETTERIA

I lavelli sono consegnati con foro diam. 35 , come indicato nel rispettivo disegno tecnico, per l'installazione dei miscelatori.

Alcuni modelli possono essere forniti con più fori, verificare su ogni specifico codice la dotazione di serie indicata.

I fori per miscelatore, sono idonei per l'installazione:

- Comandi remoti dei miscelatori
- Comandi remoti delle pilette automatiche
- Dispenser

## Informazioni tecniche

### GUARNIZIONE PREMONTATA

Un macchinario automatico applica direttamente la guarnizione al lavello, in sostituzione del lavoro manuale dell'installatore, con conseguente garanzia di un'esecuzione sempre a regola d'arte. Il prodotto è quindi dotato di guarnizione che consente la perfetta sigillatura del punto di contatto fra lavello e piano di lavoro. La macchina dosatrice miscela i due componenti che compongono lo stucco: Poliolo + Isocianato, che uniti formano una sostanza poliuretanica, completamente atossica, che viene stesa in pochi secondi lungo tutto il perimetro dei lavelli CM.

Nel giro di pochi minuti la guarnizione è asciutta ed il lavello pronto per la spedizione, nel pieno rispetto dei normali termini di consegna.



### POSIZIONAMENTO VASCHE



esempio: lavello sx

l'indicazione di versione DX o SX si riferisce alla posizione della vasca più grande del lavello.



esempio: lavello sx

nel caso di modelli dalle caratteristiche particolari (v. esempio qui a fianco), si deve fare riferimento alla posizione della vasca più grande del lavello rispetto alla più piccola.



esempio: lavello sx

per i modelli privi di gocciolatoio, occorre fare riferimento alla posizione della vasca più grande del lavello.



esempio: lavello dx

nel caso di modelli a vasca singola il cui foro di scarico non occupi una posizione centrale, occorre fare riferimento alla posizione del foro stesso per determinarne il verso.

Linea  
**LUXURYSTYLE**

Forma e sostanza, gusto ed eleganza: ogni chef che aspiri alla perfezione non può fare a meno degli uni e delle altre.

Bellezza e comodità sono la ricetta CM, nella sua linea Luxurystyle, per la più elevata qualità della vita in cucina: eccellente design italiano dalle linee rigorose e contemporanee e dalle soluzioni avanzate e innovative.

In cucina si vive e si lavora quotidianamente, perché non farlo ad alto livello?  
A partire dalla scelta del lavello e dei componenti Luxurystyle.

**LUXURYSTYLE**



STYLE

X

U

F

U B

V

## Profili

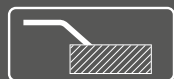

STANDARD

Il volume c'è, ma quasi non si vede. Il bordo infatti sporge dal piano di lavoro, ma in modo elegantemente impercettibile: il merito va all'inedito sistema di piegatura utilizzato da CM.

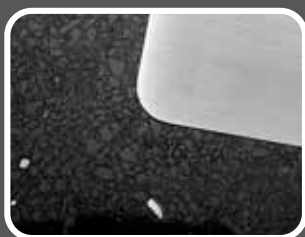

FILOTOP

Top e lavello perfettamente allineati creano un design essenziale. Bordo ultrapiatto e sistema d'aggancio avanzato: l'incasso è perfetto, minimale e rigoroso, pratico senza scomode sporgenze.



SLIM

Installarlo è facile come appoggiarlo, l'effetto è di praticità e leggerezza: solo il tatto scopre il piccolo bordo perimetrale. Eleganza e funzionalità in cucina.



SOTTOTOP

Sotto sotto c'è il lavello più innovativo, esclusivo e adatto alle soluzioni alternative. Per sfruttare al meglio gli spazi, forme rettangolari e circolari da fissare sotto il piano di lavoro.



SLIM-FILOTOP



SLIM-FILOTOP-SOTTOTOP



# Finiture



**SATINATO**

Versatilità e praticità inossidabili: opaco ma lucente, l'acciaio satinato conserva per anni, inalterati, i suoi valori di eleganza, igiene e resistenza ai graffi ed all'usura nell'uso quotidiano.



**VINTAGE**

La finitura Vintage è versatile, adatta ad ambienti moderni, tecnici e high tech. Mantenendo inalterato il colore classico dell'inossidabile l'effetto che ricorda è quello di un piano graffiato.

# Pilette e comandi



PILETTA STANDARD MANUALE



PILETTA QUADRA MANUALE



PILETTA RONDÒ MANUALE



PILETTA INTEGRATA MANUALE



PILETTA STANDARD AUTOMATICA  
con COMANDO QUADRO



PILETTA RONDÒ AUTOMATICA  
con COMANDO EASY



PILETTA QUADRA AUTOMATICA  
con COMANDO QUADRO



PILETTA INTEGRATA AUTOMATICA  
con COMANDO EASY



PILETTA RONDÒ AUTOMATICA  
con COMANDO QUADRO

# INDICE **LUXURYSTYLE**



12 ●● IN-TECH



14 ●● IN-TECH MIX



16 ●● ZEFFIRO



18 ●● SUPERIOR



20 ●● PRESTIGE



22 ●● BATIK



24 ●● ARIEL



26 ●● CALYPSO



28 ●● FOCUS



30 ●● FOCUS MIX



32 • GLAMOUR MIX



54 • BRANDO



34 • PYPYR



56 • PUNTO QUADRO



36 • FILORAGGIATO



58 • LUCE



38 • FILORAGGIATO MIX



59 • LUCE MIX



40 • VINTAGE  
• FILORAGGIATO MIX

60 • Optionals



42 • FILOQUADRA



44 • FILOQUADRA MIX



48 • ENEA



50 • VESTA



52 • EVOLUZIONE

# IN-TECH

## in-tech 38 x 44

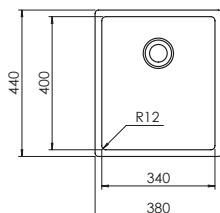

Optionals

1.5	2.3	2.12	2.13	2.14	3.2	3.18	3.19	4.6	4.15	5.6	5.7
5.9	5.10	5.11	6.6	7.6	11.1						

**017311.X0.01** satinato F3" slim cod. **07016340**

**017311.X0.01** satinato F3" filotop cod. **07016350**

**017301.X0.01** satinato F3" sottotop cod. **07016360**

base incasso : mm 450

base sottotop : mm 500

base filotop : mm 450

profondità vasca : mm 200

foro incasso : mm 370 x 430

foro sottotop : mm 340 x 400 R12

foro filotop : manuale installazione

piletta integrata manuale

## in-tech 49 x 44

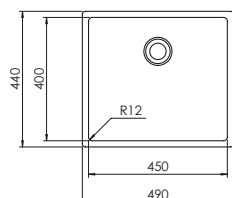

Optionals

1.5	2.3	2.12	2.13	2.14	3.2	3.18	3.19	4.6	4.16	5.6	5.7
5.9	5.10	5.11	6.6	7.6	11.1						

**017313.X0.01** satinato F3" slim cod. **07016343**

**017313.X0.01** satinato F3" filotop cod. **07016353**

**017303.X0.01** satinato F3" sottotop cod. **07016363**

base incasso : mm 600

base sottotop : mm 600

base filotop : mm 600

profondità vasca : mm 200

foro incasso : mm 480 x 430

foro sottotop : mm 450 x 400 R12

foro filotop : manuale installazione

piletta integrata manuale

## in-tech 54 x 44

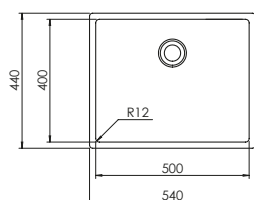

Optionals

1.5	2.3	2.12	2.13	2.14	3.2	3.18	3.19	4.6	4.16	5.6	5.7
5.9	5.10	5.11	6.6	7.6	11.1						

**017314.X0.01** satinato F3" slim cod. **07016344**

**017314.X0.01** satinato F3" filotop cod. **07016354**

**017304.X0.01** satinato F3" sottotop cod. **07016364**

base incasso : mm 600

base sottotop : mm 800

base filotop : mm 600

profondità vasca : mm 200

foro incasso : mm 530 x 430

foro sottotop : mm 500 x 400 R12

foro filotop : manuale installazione

piletta integrata manuale

## in-tech 55.5 x 44 2V

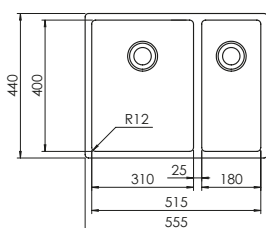

Optionals

1.5	2.3	2.12	2.13	2.14	3.6	3.19	5.6	5.7	5.9	5.10	5.11
11.1											

**017315.D0.01** satinato F3" slim dx cod. **070163451**

**017315.S0.01** satinato F3" slim sx cod. **070163452**

**017315.D0.01** satinato F3" filotop dx cod. **070163551**

**017315.S0.01** satinato F3" filotop sx cod. **070163552**

**017305.D0.01** satinato F3" sottotop dx cod. **070163651**

**017305.S0.01** satinato F3" sottotop sx cod. **070163652**

base incasso : mm 600

base sottotop : mm 800

base filotop : mm 600

profondità vasche : mm 200 - 170

foro incasso : mm 545 x 430

foro sottotop : mm 515 x 400 R12

foro filotop : manuale installazione

versione DX e SX

piletta integrata manuale

### in-tech 74 x 44

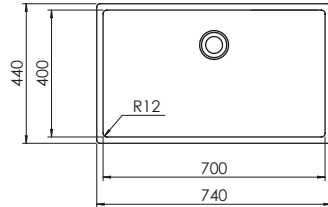

Optionals

1.5	2.3	2.12	2.13	2.14	3.2	3.18	3.19	4.6	4.17	5.6	5.7
5.9	5.10	5.11	6.6	7.6	11.1						

**017316.X0.01** satinato F3" slim cod. **07016346**

**017316.X0.01** satinato F3" filotop cod. **07016356**

**017306.X0.01** satinato F3" sottotop cod. **07016366**

base incasso : mm 800  
 base sottotop : mm 900  
 base filotop : mm 800  
 profondità vasca : mm 200  
 foro incasso : mm 730 x 430  
 foro sottotop : mm 700 x 400 R12  
 foro filotop : manuale installazione  
 piletta integrata manuale

### in-tech 74.5 x 44 2V

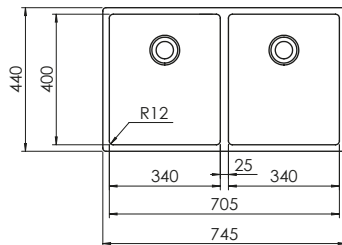

Optionals

1.5	2.3	2.12	2.13	2.14	3.2	3.18	3.19	4.6	4.15	5.6	5.7
5.9	5.10	5.11	6.6	7.6	11.1						

**017317.X0.01** satinato F3" slim cod. **07016347**

**017317.X0.01** satinato F3" filotop cod. **07016357**

**017307.X0.01** satinato F3" sottotop cod. **07016367**

base incasso : mm 800  
 base sottotop : mm 900  
 base filotop : mm 800  
 profondità vasche : mm 200  
 foro incasso : mm 735 x 430  
 foro sottotop : mm 705 x 400 R12  
 foro filotop : manuale installazione  
 piletta integrata manuale





# IN-TECH MIX

## in-tech mix 39 x 51

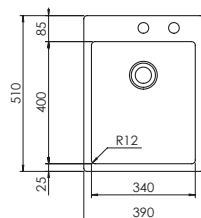

Optionals

1.5	2.3	2.12	2.13	2.14	3.2	3.18	3.19	4.6	4.15	5.6	5.7
5.9	5.10	5.11	6.6	7.6	11.1						

**017321.X2.01** satinato F3" slim cod. **07016380**

**017321.X2.01** satinato F3" filotop cod. **07016390**

base incasso : mm 450  
base filotop : mm 450  
profondità vasca : mm 200  
foro incasso : mm 375 x 495  
foro filotop : manuale installazione  
piletta integrata automatica con comando easy

## in-tech mix 45 x 51

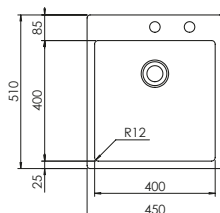

Optionals

1.5	2.3	2.12	2.13	2.14	3.2	3.18	3.19	4.6	4.15	5.6	5.7
5.9	5.10	5.11	6.6	7.6	11.1						

**017322.X2.01** satinato F3" slim cod. **07016381**

**017322.X2.01** satinato F3" filotop cod. **07016391**

base incasso : mm 500  
base filotop : mm 500  
profondità vasca : mm 200  
foro incasso : mm 435 x 495  
foro filotop : manuale installazione  
piletta integrata automatica con comando easy

## in-tech mix 50 x 51

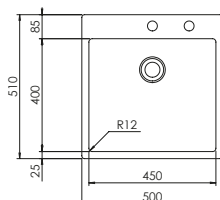

Optionals

1.5	2.3	2.12	2.13	2.14	3.2	3.18	3.19	4.6	4.16	5.6	5.7
5.9	5.10	5.11	6.6	7.6	11.1						

**017323.X2.01** satinato F3" slim cod. **07016382**

**017323.X2.01** satinato F3" filotop cod. **07016392**

base incasso : mm 600  
base filotop : mm 600  
profondità vasca : mm 200  
foro incasso : mm 485 x 495  
foro filotop : manuale installazione  
piletta integrata automatica con comando easy

## in-tech mix 55 x 51

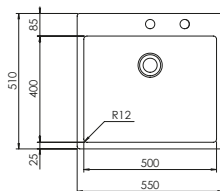

Optionals

1.5	2.3	2.12	2.13	2.14	3.2	3.18	3.19	4.6	4.16	5.6	5.7
5.9	5.10	5.11	6.6	7.6	11.1						

**017324.X2.01** satinato F3" slim cod. **07016383**

**017324.X2.01** satinato F3" filotop cod. **07016393**

base incasso : mm 600  
base filotop : mm 600  
profondità vasca : mm 200  
foro incasso : mm 535 x 495  
foro filotop : manuale installazione  
piletta integrata automatica con comando easy

### in-tech mix 56.5 x 51 2V

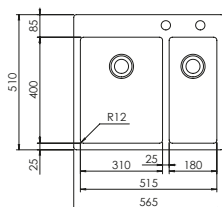

Optionals

1.5	2.3	2.12	2.13	2.14	3.6	3.19	5.6	5.7	5.9	5.10	5.11
11.1											

**017325.D2.01** satinato F3" slim dx cod. **070163841**

**017325.S2.01** satinato F3" slim sx cod. **070163842**

**017325.D2.01** satinato F3" filotop dx cod. **070163941**

**017325.S2.01** satinato F3" filotop sx cod. **070163942**

base incasso : mm 600

base filotop : mm 600

profondità vasche: mm 200 - 170

foro incasso : mm 550 x 495

foro filotop: manuale installazione

versione DX e SX

piletta integrata automatica con comando easy

### in-tech mix 75 x 51

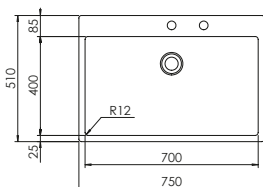

Optionals

1.5	2.3	2.12	2.13	2.14	3.2	3.18	3.19	4.6	4.17	5.6	5.7
5.9	5.10	5.11	6.6	7.6	11.1						

**017326.X2.01** satinato F3" slim cod. **07016386**

**017326.X2.01** satinato F3" filotop cod. **07016396**

base incasso : mm 800

base filotop : mm 800

profondità vasca: mm 200

foro incasso: mm 735 x 495

foro filotop : manuale installazione

piletta integrata automatica con comando easy

### in-tech mix 75.5 x 51 2V

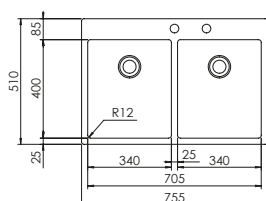

Optionals

1.5	2.3	2.12	2.13	2.14	3.2	3.18	3.19	4.6	4.15	5.6	5.7
5.9	5.10	5.11	6.6	7.6	11.1						

**017327.X0.01** satinato F3" slim cod. **07016387**

**017327.X0.01** satinato F3" filotop cod. **07016397**

base incasso: mm 800

base filotop: mm 800

profondità vasche : mm 200

foro incasso : mm 740 x 495

foro filotop : manuale installazione

piletta integrata automatica con comando easy

# ZEFFIRO

## zeffiro 58.5 x 44 2V

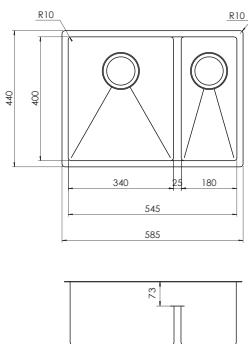

Optionals

1.5	2.3	2.12	2.13	2.14	3.2	3.8	3.18	3.19	4.6	4.15	5.6
5.7	5.9	5.10	5.11	6.6	7.6	11.1					

**012081.DO.01** satinato F3" slim dx cod. **07020651**

**012081.SO.01** satinato F3" slim sx cod. **07020652**

**012081.DO.01** satinato F3" sottotop dx cod. **07020661**

**012081.SO.01** satinato F3" sottotop sx cod. **07020662**

**012081.DO.01** satinato F3" filotop dx cod. **07020671**

**012081.SO.01** satinato F3" filotop sx cod. **07020672**

base incasso: mm 800

base sottotop : mm 800

base filotop : mm 800

profondità vasche: mm 190

foro incasso : mm 575 x 430

foro sottotop : mm 545 x 400 R10

foro filotop : manuale installazione

versione DX e SX

piletta rondò manuale

fascia centrale ribassata di 73 mm

## zeffiro 74.5 x 44 2V

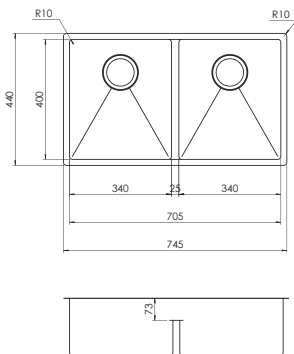

Optionals

1.5	2.3	2.12	2.13	2.14	3.2	3.8	3.18	3.19	4.6	4.15	5.6
5.7	5.9	5.10	5.11	6.6	7.6	11.1					

**012082.XO.01** satinato F3" slim cod. **07020680**

**012082.XO.01** satinato F3" sottotop cod. **07020682**

**012082.XO.01** satinato F3" filotop cod. **07020684**

base incasso : mm 800

base sottotop : mm 900

base filotop: mm 800

profondità vasche : mm 190

foro incasso: mm 735 x 430

foro sottotop: mm 705 x 400 R10

foro filotop : manuale installazione

piletta rondò manuale

fascia centrale ribassata di 73 mm



**fascia centrale ribassata rispetto al profilo**



# SUPERIOR

## superior 86 x 50

**015553.X2.01** satinato F3" slim cod. **07020151**

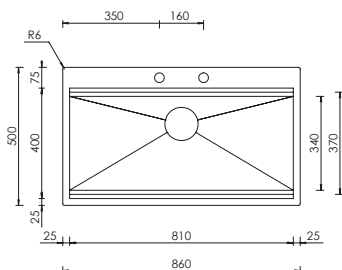

base : mm 900  
 profondità vasca : mm 250  
 foro incasso : mm 840 x 480  
 piletta rondò automatica con comando quadro

Optionals

2.10 | 3.12 | 4.8 | 5.1 | 5.7 | 5.9 | 5.10 | 11.1

## superior 100 x 50

**015556.X2.01** satinato F3" slim cod. **07020161**

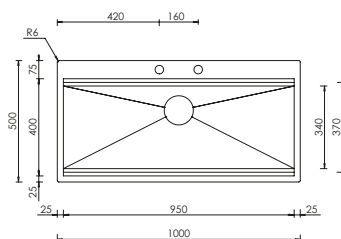

base : mm 1200  
 profondità vasca : mm 250  
 foro incasso : mm 980 x 480  
 piletta rondò automatica con comando quadro

Optionals

2.10 | 3.12 | 4.8 | 5.1 | 5.7 | 5.9 | 5.10 | 11.1

## superior 116 x 50

**015557.X2.01** satinato F3" slim cod. **07020171**

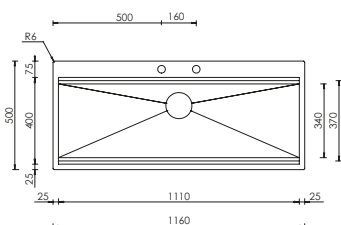

base : mm 1200  
 profondità vasca : mm 250  
 foro incasso : mm 1140 x 480  
 piletta rondò automatica con comando quadro

Optionals

2.10 | 3.12 | 4.8 | 5.1 | 5.7 | 5.9 | 5.10 | 11.1





# PRESTIGE

## prestige 100 x 50 1V

**012706.X2.01** satinato F3" slim

base : mm 450 / mm 800 se inizio composizione  
 base : mm 1200 per piano inferiore 30 mm  
 profondità vasca : mm 190  
 foro incasso : mm 980 x 480  
 piletta standard automatica con comando quadro

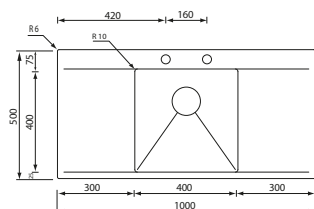

Optionals

1.5	2.3	2.12	2.13	2.14	3.2	3.8	3.18	3.19	4.6	4.15	5.6
5.7	5.9	5.10	5.11	6.6	7.6	11.1					

## prestige 116 x 50 1V

**012709.X2.01** satinato F3" slim

base : mm 500 / mm 900 se inizio composizione  
 base : mm 1200 per piano inferiore 30 mm  
 profondità vasca : mm 190  
 foro incasso : mm 1140 x 480  
 piletta standard automatica con comando quadro

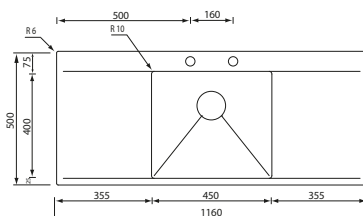

Optionals

1.5	2.3	2.12	2.13	2.14	3.2	3.8	3.18	3.19	4.6	4.16	5.6
5.7	5.9	5.10	5.11	6.6	7.6	11.1					

## prestige 116 x 50 2V

**012707.X2.01** satinato F3" slim

base : mm 600 / mm 900 se inizio composizione  
 base : mm 1200 per piano inferiore 30 mm  
 profondità vasche : mm 190 - 140  
 foro incasso : mm 1140 x 480  
 piletta standard automatica con comando quadro

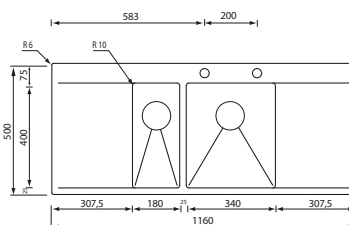

Optionals

1.5	2.3	2.12	2.13	2.14	3.2	3.8	3.18	3.19	4.6	4.15	5.6
5.7	5.9	5.10	5.11	6.6	7.6	11.1					



# BATİK

## batik 77 x 50 2V

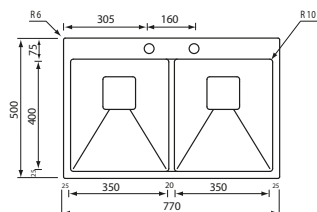

Optionals

1.5	2.3	2.12	2.13	2.14	3.2	3.8	3.18	3.19	4.6	5.6	5.7
5.9	5.10	5.11	6.6	7.6	11.1						

**012032.X2.01** satinato F3" slim cod. **07011507**

base: mm 800  
 profondità vasche: mm 190  
 foro incasso : mm 750 x 480  
 piletta quadra automatica con comando quadro

## batik 86 x 50 1V

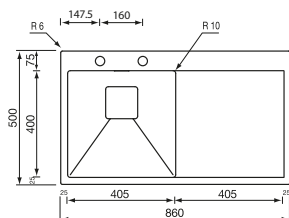

Optionals

1.5	2.3	2.12	2.13	2.14	3.2	3.8	3.18	3.19	4.6	5.6	5.7
5.9	5.10	5.11	6.6	7.6	11.1						

**012033.D2.01** satinato F3" slim dx cod. **07011511**

**012033.S2.01** satinato F3" slim sx cod. **07011512**

base : mm 450 / mm 500 se inizio composizione  
 base : mm 900 per piano inferiore 30 mm  
 profondità vasca : mm 190  
 foro incasso : mm 840 x 480  
 versione DX e SX  
 piletta quadra automatica con comando quadro

## batik 100 x 50 1V

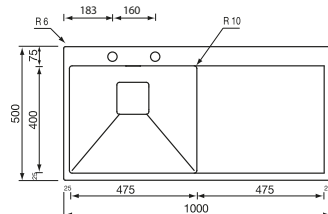

Optionals

1.5	2.3	2.12	2.13	2.14	3.2	3.8	3.18	3.19	4.6	5.6	5.7
5.9	5.10	5.11	6.6	7.6	11.1						

**012036.D2.01** satinato F3" slim dx cod. **07011521**

**012036.S2.01** satinato F3" slim sx cod. **07011522**

base mm 600  
 base : mm 1200 per piano inferiore 30 mm  
 profondità vasca : mm 190  
 foro incasso : mm 980 x 480  
 versione DX e SX  
 piletta quadra automatica con comando quadro

## batik 100 x 50 2V

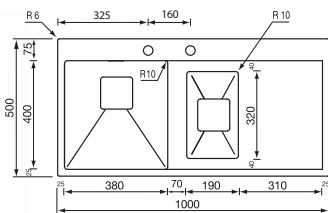

Optionals

1.5	2.3	2.12	2.13	2.14	3.2	3.4	3.8	3.18	3.19	4.6	5.6
5.7	5.9	5.10	5.11	6.6	7.6	11.1					

**012035.D2.01** satinato F3" slim dx cod. **07011531**

**012035.S2.01** satinato F3" slim sx cod. **07011532**

base: mm 800  
 base : mm 1200 per piano inferiore 30 mm  
 profondità vasche : mm 190 - 130  
 foro incasso : mm 980 x 480  
 versione DX e SX  
 piletta quadra automatica con comando quadro



## batik 116 x 50 2V

**012037.D2.01** satinato F3" slim dx cod. **07011541**

**012037.S2.01** satinato F3" slim sx cod. **07011542**

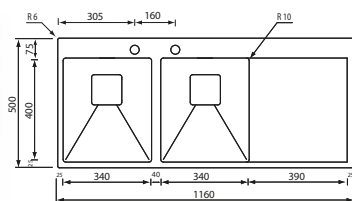

base: mm 800

base: mm 1200 per piano inferiore 30 mm

profondità vasche: mm 190

foro incasso : mm 1140 x 480

versione DX e SX

pietta quadra automatica con comando quadro

### Optionals

1.5	2.2	2.3	2.12	2.13	2.14	3.2	3.8	3.18	3.19	4.6	5.6
-----	-----	-----	------	------	------	-----	-----	------	------	-----	-----

5.7	5.9	5.10	5.11	6.6	7.6	11.1
-----	-----	------	------	-----	-----	------





# ARIEL

## ariel 45 x 50

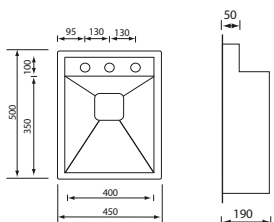

### Optionals

4.8 | 6.2 | 7.1 | 11.1

**012910.X3.01** satinato F3" slim cod. **07011700**

**012900.X3.01** satinato F3" sottotop cod. **07011705**

base incasso : mm 500  
base sottotop: mm 600  
profondità vasca : mm 190  
foro incasso mm 430 x 480  
foro sottotop : mm 400 x 450  
piletta quadra automatica con comando quadro

Nota: il 3° foro prevede l'inserimento del miscelatore con comando remoto oppure del dispenser.

## ariel 59 x 50

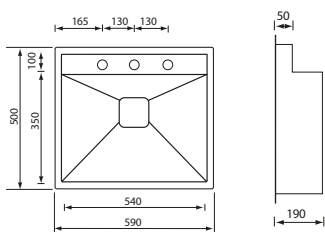

### Optionals

4.8 | 6.2\* | 7.1\* | 11.1

**012912.X3.01** satinato F3" slim cod. **07011332**

**012902.X3.01** satinato F3" sottotop cod. **07011322**

base incasso : mm 800  
base sottotop : mm 800  
profondità vasca : mm 190  
foro incasso : mm 570 x 480  
foro sottotop : mm 540 x 450  
piletta quadra automatica con comando quadro

Nota: il 3° foro prevede l'inserimento del miscelatore con comando remoto oppure del dispenser.

## ariel 77 x 50

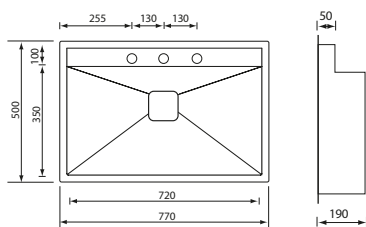

### Optionals

4.8 | 6.2\* | 7.1\* | 11.1

**012913.X3.01** satinato F3" slim cod. **07011334**

**012903.X3.01** satinato F3" sottotop cod. **07011324**

base incasso : mm 800  
base sottotop : mm 900  
profondità vasca : mm 190  
foro incasso : mm 750 x 480  
foro sottotop : mm 720 x 450  
piletta quadra automatica con comando quadro

Nota: il 3° foro prevede l'inserimento del miscelatore con comando remoto oppure del dispenser.

## ariel 86 x 50 2V

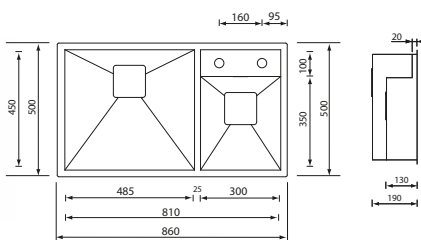

### Optionals

2.8 | 3.10 | 4.1 | 6.2 | 7.1 | 8.1 | 11.1

**012914.D2.01** satinato F3" slim dx cod. **07011711**

**012914.S2.01** satinato F3" slim sx cod. **07011712**

**012904.D2.01** satinato F3" sottotop dx cod. **07011751**

**012904.S2.01** satinato F3" sottotop sx cod. **07011752**

base incasso : mm 900  
base sottotop : mm 1000  
profondità vasche : mm 190 - 130  
foro incasso : mm 840 x 480  
foro sottotop : mm 810 x 450  
versione DX e SX  
piletta quadra automatica con comando quadro



# CALYPSO

## calypso 51 x 51

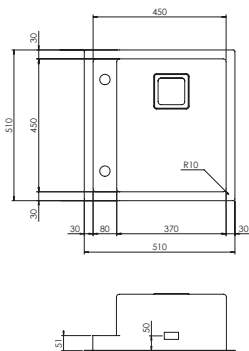

Optionals

3.10 | 4.1 | 6.2 | 7.1 | 8.1 | 11.1

**015600.D2.01** satinato F3" slim cod. **07011800**

**015610.D2.01** satinato F3" sottotop cod. **07011805**

base incasso : mm 600  
base sottotop : mm 600  
profondità vasca : mm 190  
foro incasso : mm 480 x 480  
foro sottotop : mm 450x450 R10  
piletta quadra manuale

## calypso 58 x 51

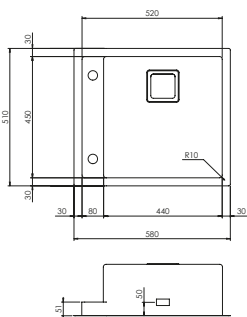

Optionals

3.10 | 4.1 | 6.2 | 7.1 | 8.1 | 11.1

**015601.D2.01** satinato F3" slim cod. **07011810**

**015611.D2.01** satinato F3" sottotop cod. **07011815**

base incasso : mm 600  
base sottotop : mm 800  
profondità vasca : mm 190  
foro incasso : mm 550 x 480  
foro sottotop : mm 520x450 R10  
piletta quadra manuale

## calypso 78 x 51

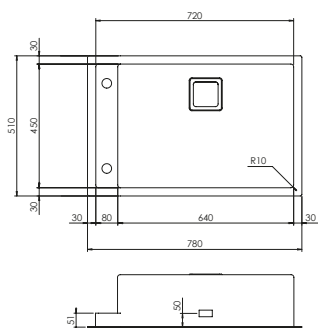

Optionals

3.10 | 4.1 | 6.2\* | 7.1\* | 8.1\* | 11.1

**015602.D2.01** satinato F3" slim cod. **07011820**

**015612.D2.01** satinato F3" sottotop cod. **07011825**

base incasso : mm 800  
base sottotop : mm 900  
profondità vasca : mm 190  
foro incasso : mm 750 x 480  
foro sottotop : mm 720x450 R10  
piletta quadra manuale

## calypso 94 x 51 2V

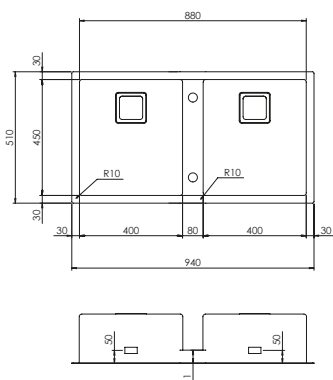

Optionals

3.10 | 4.1 | 6.2\* | 7.1\* | 8.1\* | 11.1

**015603.X2.01** satinato F3" slim cod. **07011830**

**015613.X2.01** satinato F3" sottotop cod. **07011835**

base incasso : mm 1000  
base sottotop : mm 1200  
profondità vasche : mm 190  
foro incasso : mm 910 x 480  
foro sottotop : mm 880x450 R10  
piletta quadra manuale





# FOCUS

## focus 45 x 45

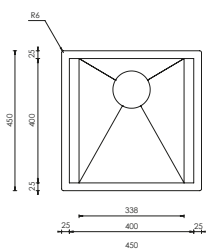

Optionals

1.5	2.9	2.13	2.14	3.11	4.6	4.15	5.6	5.7	5.9	5.10	5.11
6.6	7.6	11.1									

**015201.X0.01** satinato F3" slim cod. **07014721**

**015211.X0.01** satinato F3" sottotop cod. **07014731**

base incasso : mm 500  
base sottotop : mm 600  
profondità vasca : mm 190  
foro incasso : mm 430 x 430  
foro sottotop : mm 400 x 400  
piletta standard manuale

## focus 50 x 45

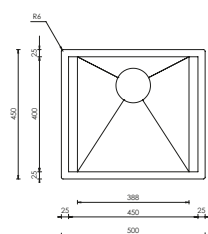

Optionals

1.5	2.9	2.13	2.14	3.11	4.6	4.15	5.6	5.7	5.9	5.10	5.11
6.6	7.6	11.1									

**015206.X0.01** satinato F3" slim cod. **07014722**

**015216.X0.01** satinato F3" sottotop cod. **07014732**

base incasso : mm 500  
base sottotop : mm 600  
profondità vasca : mm 190  
foro incasso : mm 480 x 430  
foro sottotop : mm 450 x 400  
piletta standard manuale

## focus 57 x 45

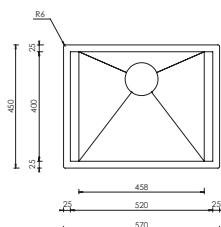

Optionals

1.5	2.9	2.13	2.14	3.11	4.6	4.16	5.6	5.7	5.9	5.10	5.11
6.6	7.6	11.1									

**015202.X0.01** satinato F3" slim cod. **07014723**

**015212.X0.01** satinato F3" sottotop cod. **07014733**

base incasso : mm 600  
base sottotop : mm 800  
profondità vasca : mm 190  
foro incasso : mm 550 x 430  
foro sottotop : mm 520 x 400  
piletta standard manuale

## focus 77 x 45

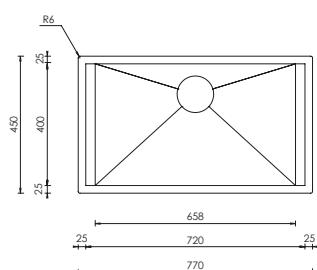

Optionals

1.5	2.9	2.13	2.14	3.11	4.6	4.17	5.6	5.7	5.9	5.10	5.11
6.6	7.6	11.1									

**015203.X0.01** satinato F3" slim cod. **07014726**

**015213.X0.01** satinato F3" sottotop cod. **07014736**

base incasso : mm 800  
base sottotop : mm 900  
profondità vasca : mm 190  
foro incasso : mm 750 x 430  
foro sottotop : mm 720x 400  
piletta standard manuale

### focus 86 x 45

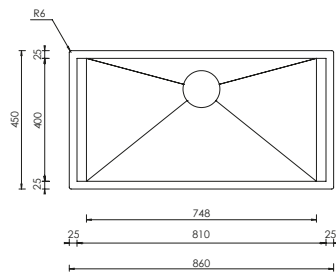

Optionals

1.5	2.9	2.13	2.14	3.11	4.6	4.17	5.6	5.7	5.9	5.10	5.11
6.6	7.6	11.1									

**015204.X0.01** satinato F3" slim cod. **07014728**

**015214.X0.01** satinato F3" sottotop cod. **07014738**

base incasso : mm 900  
 base sottotop: mm 1000  
 profondità vasca : mm 190  
 foro incasso: mm 840 x 430  
 foro sottotop : mm 810 x 400  
 piletta standard manuale

### focus 87.5 x 45 2V

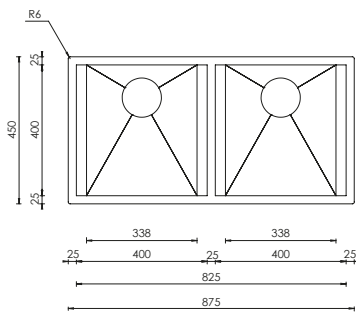

Optionals

1.5	2.9	2.13	2.14	3.11	4.6	4.15	5.6	5.7	5.9	5.10	5.11
6.6	7.6	11.1									

**015205.X0.01** satinato F3" slim cod. **07014729**

**015215.X0.01** satinato F3" sottotop cod. **07014739**

base incasso : mm 900  
 base sottotop: mm 1000  
 profondità vasche: mm 190  
 foro incasso: mm 855 x 430  
 foro sottotop : mm 825 x 400  
 piletta standard manuale



# FOCUS MIX

## focus mix 45 x 50

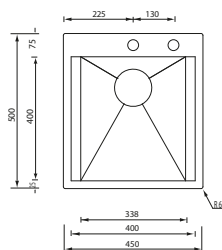

Optionals

1.5	2.9	2.13	2.14	3.11	4.6	4.15	5.6	5.7	5.9	5.10	5.11
6.6	7.6	11.1									

**015221.X2.01** satinato F3" slim cod. **07014750**

base : mm 500  
 profondità vasca: mm 190  
 foro incasso : mm 430 x 480  
 piletta standard automatica con comando quadro

## focus mix 50 x 50

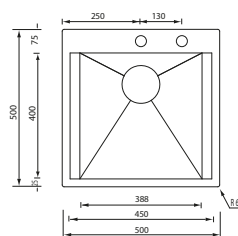

Optionals

1.5	2.9	2.13	2.14	3.11	4.6	4.15	5.6	5.7	5.9	5.10	5.11
6.6	7.6	11.1									

**015226.X2.01** satinato F3" slim cod. **07014755**

base : mm 500  
 profondità vasca : mm 190  
 foro incasso : mm 480 x 480  
 piletta standard automatica con comando quadro

## focus mix 57 x 50

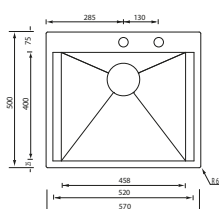

Optionals

1.5	2.9	2.13	2.14	3.11	4.6	4.16	5.6	5.7	5.9	5.10	5.11
6.6	7.6	11.1									

**015222.X2.01** satinato F3" slim cod. **07014760**

base : mm 600  
 profondità vasca : mm 190  
 foro incasso : mm 550 x 480  
 piletta standard automatica con comando quadro

## focus mix 77 x 50

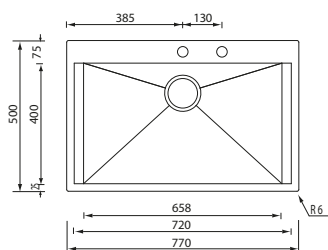

Optionals

1.5	2.9	2.13	2.14	3.11	4.6	4.17	5.6	5.7	5.9	5.10	5.11
6.6	7.6	11.1									

**015223.X2.01** satinato F3" slim cod. **07014765**

base : mm 800  
 profondità vasca: mm 190  
 foro incasso : mm 750 x 480  
 piletta standard automatica con comando quadro



### focus mix 86 x 50

**015224.X2.01** satinato F3" slim cod. **07014770**

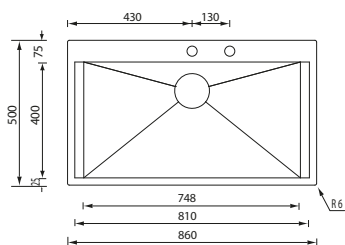

base : mm 900  
profondità vasca : mm 190  
foro incasso : mm 840 x 480  
piletta standard automatica con comando quadro

Optionals

1.5	2.9	2.13	2.14	3.11	4.6	4.17	5.6	5.7	5.9	5.10	5.11
6.6	7.6	11.1									

### focus mix 87.5 x 50 2V

**015225.X3.01** satinato F3" slim cod. **07014780**

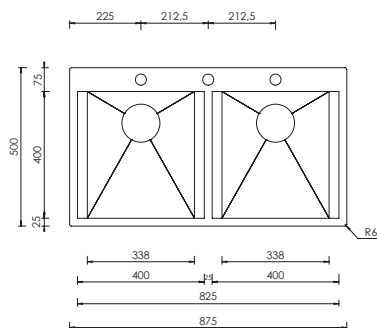

base : mm 900  
profondità vasche : mm 190  
foro incasso : mm 855 x 480  
piletta standard automatica con comando quadro

Optionals

1.5	2.9	2.13	2.14	3.11	4.6	4.15	5.6	5.7	5.9	5.10	5.11
6.6	7.6	11.1									



# GLAMOUR MIX

## glamour mix 45 x 50

**012821.X2.01** satinato F3" slim cod. **07011604**

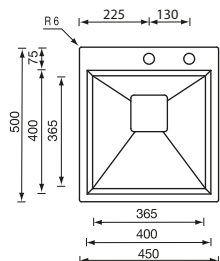

base: mm 500  
 profondità vasca : mm 190  
 foro incasso : mm 430 x 480  
 piletta quadra automatica con comando quadro

Optionals

2.7 | 3.9 | 4.8 | 7.2 | 11.1

## glamour mix 57 x 50

**012822.X2.01** satinato F3" slim cod. **07011605**

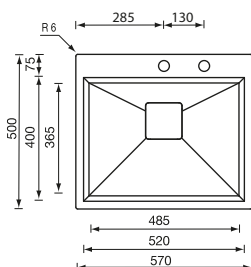

base : mm 600  
 profondità vasca : mm 190  
 foro incasso : mm 550 x 480  
 piletta quadra automatica con comando quadro

Optionals

2.7 | 3.9 | 4.8 | 7.2 | 11.1

## glamour mix 77 x 50

**012823.X2.01** satinato F3" slim cod. **07011607**

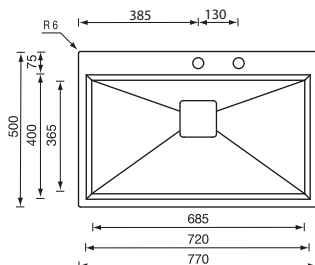

base : mm 800  
 profondità vasca : mm 190  
 foro incasso : mm 750 x 480  
 piletta quadra automatica con comando quadro

Optionals

2.7 | 3.9 | 4.8 | 7.2 | 11.1

## glamour mix 86 x 50

**012824.X2.01** satinato F3" slim cod. **07011608**

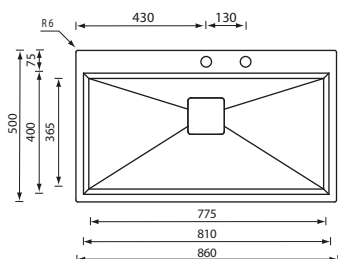

base : mm 900  
 profondità vasca : mm 190  
 foro incasso : mm 840 x 480  
 piletta quadra automatica con comando quadro

Optionals

2.7 | 3.9 | 4.8 | 7.2 | 11.1



# PYPER

## pyper 45 x 45

**015322.X0.01** satinato F3" slim cod. **07011850**

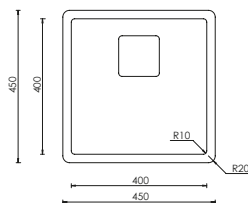

base incasso : mm 500  
 profondità vasca : mm 250  
 foro incasso : mm 430 x 430  
 piletta quadra manuale

Optionals

1.5	2.3	2.12	2.13	2.14	3.2	3.8	3.18	3.19	4.6	5.6	5.7
5.9	5.10	5.11	6.6	7.6	11.1						

## pyper 57 x 45

**015326.X0.01** satinato F3" slim cod. **07011860**

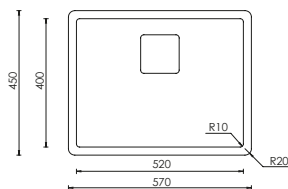

base incasso : mm 600  
 profondità vasca : mm 250  
 foro incasso mm 550 x 430  
 piletta quadra manuale

Optionals

1.5	2.3	2.12	2.13	2.14	3.2	3.8	3.18	3.19	4.6	5.6	5.7
5.9	5.10	5.11	6.6	7.6	11.1						

## pyper 77 x 45

**015328.X0.01** satinato F3" slim cod. **07011870**

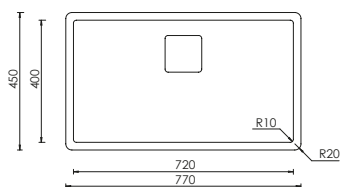

base incasso : mm 800  
 profondità vasca : mm 250  
 foro incasso : mm 750 x 430  
 piletta quadra manuale

Optionals

1.5	2.3	2.12	2.13	2.14	3.2	3.8	3.18	3.19	4.6	5.6	5.7
5.9	5.10	5.11	6.6	7.6	11.1						

## pyper 85 x 45

**01532A.X0.01** satinato F3" slim cod. **07011880**

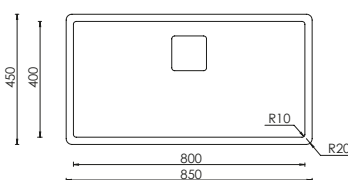

base incasso : mm 900  
 profondità vasca : mm 250  
 foro incasso : mm 830 x 430  
 piletta quadra manuale

Optionals

1.5	2.3	2.12	2.13	2.14	3.2	3.8	3.18	3.19	4.6	5.6	5.7
5.9	5.10	5.11	6.6	7.6	11.1						

**pyper 89 x 45 2V**

**01532B.X0.01** satinato F3" slim cod. **07011890**

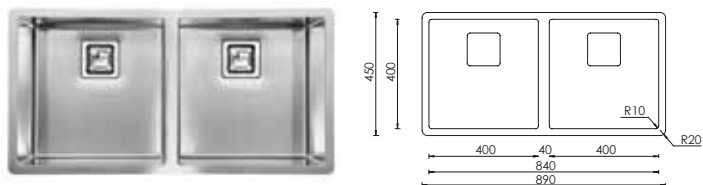

base incasso : mm 900  
profondità vasche : mm 250  
foro incasso : mm 870 x 430  
piletta quadra manuale

Optionals

1.5	2.2	2.3	2.12	2.13	2.14	3.2	3.8	3.18	3.19	4.6	5.6
5.7	5.9	5.10	5.11	6.6	7.6	11.1					





# FIORAGGIATO

## filoraggiato 39 x 45

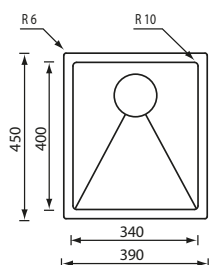

Optionals

1.5	2.3	2.12	2.13	2.14	3.2	3.18	3.19	4.6	4.15	5.6	5.7
5.9	5.10	5.11	6.6	7.6	11.1						

**012024.X0.01** satinato F3" slim cod. **07011390**

**012004.X0.01** satinato F3" sottotop cod. **07011400**

base incasso : mm 450  
base sottotop : mm 600  
profondità vasca : mm 190  
foro incasso : mm 370 x 430  
foro sottotop : mm 340 x 400 R10  
piletta standard manuale

## filoraggiato 45 x 45

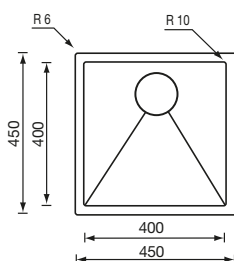

Optionals

1.5	2.3	2.12	2.13	2.14	3.2	3.18	3.19	4.6	4.15	5.6	5.7
5.9	5.10	5.11	6.6	7.6	11.1						

**012022.X0.01** satinato F3" slim cod. **07011391**

**012002.X0.01** satinato F3" sottotop cod. **07011401**

base incasso : mm 500  
base sottotop : mm 600  
profondità vasca : mm 190  
foro incasso : mm 430 x 430  
foro sottotop : mm 400 x 400 R10  
piletta standard manuale

## filoraggiato 57 x 45

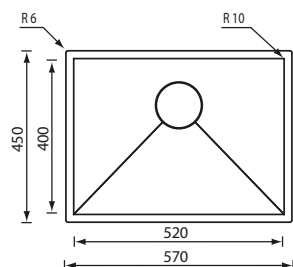

Optionals

1.5	2.3	2.12	2.13	2.14	3.2	3.18	3.19	4.6	4.16	5.6	5.7
5.9	5.10	5.11	6.6	7.6	11.1						

**012028.X0.01** satinato F3" slim cod. **07011392**

**012008.X0.01** satinato F3" sottotop cod. **07011402**

base incasso : mm 600  
base sottotop : mm 800  
profondità vasca : mm 190  
foro incasso : mm 550 x 430  
foro sottotop : mm 520 x 400 R10  
piletta standard manuale

## filoraggiato 77 x 45

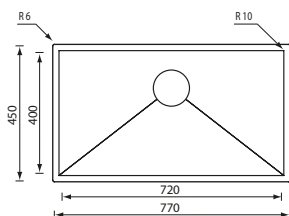

Optionals

1.5	2.3	2.12	2.13	2.14	3.2	3.18	3.19	4.6	4.17	5.6	5.7
5.9	5.10	5.11	6.6	7.6	11.1						

**012026.X0.01** satinato F3" slim cod. **07011394**

**012006.X0.01** satinato F3" sottotop cod. **07011404**

base incasso : mm 800  
base sottotop : mm 900  
profondità vasca : mm 190  
foro incasso : mm 750 x 430  
foro sottotop : mm 720 x 400 R10  
piletta standard manuale

**filoraggiato 77 x 45 2V**

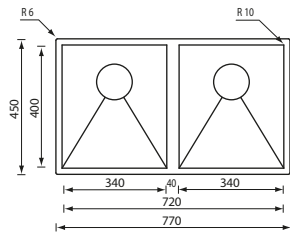

**012029.X0.01** satinato F3" slim cod. **07011396**

**012009.X0.01** satinato F3" sottotop cod. **07011406**

base incasso : mm 800  
 base sottotop : mm 900  
 profondità vasche : mm 190  
 foro incasso : mm 750 x 430  
 foro sottotop : mm 720 x 400 R10  
 piletta standard manuale

Optionals

1.5	2.2	2.3	2.12	2.13	2.14	3.2	3.18	3.19	4.6	4.15	5.6
5.7	5.9	5.10	5.11	6.6	7.6	11.1					





# FIORAGGIATO MIX

## filoraggiato mix 39 x 50

**012042.X1.01** satinato F3" slim cod. **07011450**

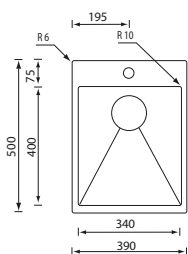

base: mm 450  
 profondità vasca : mm 190  
 foro incasso : mm 370 x 480  
 piletta standard manuale

Optionals

1.5	2.3	2.12	2.13	2.14	3.2	3.18	3.19	4.6	4.15	5.6	5.7
5.9	5.10	5.11	6.6	7.6	11.1						

## filoraggiato mix 45 x 50

**012043.X1.01** satinato F3" slim cod. **07011451**

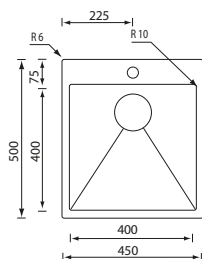

base: mm 500  
 profondità vasca: mm 190  
 foro incasso: mm 430 x 480  
 piletta standard manuale

Optionals

1.5	2.3	2.12	2.13	2.14	3.2	3.18	3.19	4.6	4.15	5.6	5.7
5.9	5.10	5.11	6.6	7.6	11.1						

## filoraggiato mix 57 x 50

**012044.X1.01** satinato F3" slim cod. **07011452**

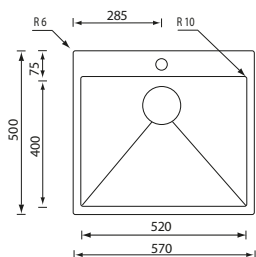

base : mm 600  
 profondità vasca: mm 190  
 foro incasso : mm 550 x 480  
 piletta standard manuale

Optionals

1.5	2.3	2.12	2.13	2.14	3.2	3.18	3.19	4.6	4.16	5.6	5.7
5.9	5.10	5.11	6.6	7.6	11.1						

## filoraggiato mix 77 x 50

**012046.X1.01** satinato F3" slim cod. **07011456**

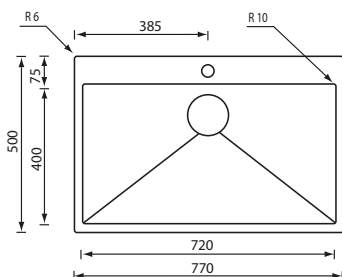

base : mm 800  
 profondità vasca : mm 190  
 foro incasso : mm 750 x 480  
 piletta standard manuale

Optionals

1.5	2.3	2.12	2.13	2.14	3.2	3.18	3.19	4.6	4.17	5.6	5.7
5.9	5.10	5.11	6.6	7.6	11.1						

**filoraggiato mix 77 x 50 2V**

**012048.X2.01** satinato F3" slim cod. **07011457**

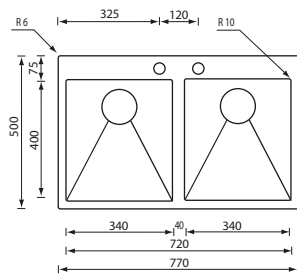

base : mm 800  
profondità vasche: mm 190  
foro incasso : mm 750 x 480  
piletta standard automatica con comando quadro

Optionals

1.5	2.2	2.3	2.12	2.13	2.14	3.2	3.18	3.19	4.6	4.15	5.6
5.7	5.9	5.10	5.11	6.6	7.6	11.1					



# FIORAGGIATO MIX VINTAGE

## filoraggiato mix vintage 45 x 50

**072043.X1.01** vintage F3" slim cod. **07011481**

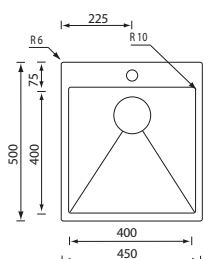

base: mm 500  
 profondità vasca: mm 190  
 foro incasso: mm 430 x 480  
 piletta rondò manuale

Optionals

1.5 | 4.6 | 4.15 | 5.6 | 5.7 | 5.9 | 5.10 | 6.6 | 7.6 | 11.1

## filoraggiato mix vintage 57 x 50

**072044.X1.01** vintage F3" slim cod. **07011482**

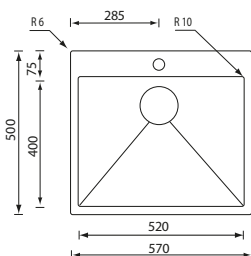

base: mm 600  
 profondità vasca: mm 190  
 foro incasso : mm 550 x 480  
 piletta rondò manuale

Optionals

1.5 | 4.6 | 4.16 | 5.6 | 5.7 | 5.9 | 5.10 | 6.6 | 7.6 | 11.1

## filoraggiato mix vintage 77 x 50

**072046.X1.01** vintage F3" slim cod. **07011483**

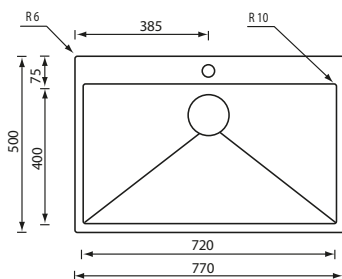

base: mm 800  
 profondità vasca: mm 190  
 foro incasso : mm 750 x 480  
 piletta rondò manuale

Optionals

1.5 | 4.6 | 4.17 | 5.6 | 5.7 | 5.9 | 5.10 | 6.6 | 7.6 | 11.1

## filoraggiato mix vintage 77 x 50 2V

**072048.X2.01** vintage F3" slim cod. **07011484**

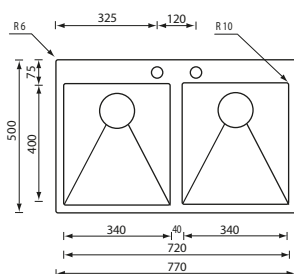

base : mm 800  
 profondità vasche : mm 190  
 foro incasso: mm 750 x 480  
 piletta rondò automatica con comando quadro

Optionals

1.5 | 4.6 | 4.15 | 5.6 | 5.7 | 5.9 | 5.10 | 6.6 | 7.6 | 11.1



# FILOQUADRA

## filoquadra 39 x 45 x 5

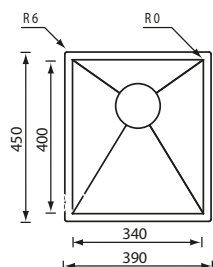

Optionals

1.5	3.2	3.18	3.19	4.15	5.6	5.7	5.9	5.10	5.11	6.6	7.6
-----	-----	------	------	------	-----	-----	-----	------	------	-----	-----

11.1
------

**011907.X0.01** satinato F3" slim cod. **07011340**

**011917.X0.01** satinato F3" sottotop cod. **07011360**

**011927.X0.01** satinato F3" filotop cod. **07011350**

base incasso : mm 450  
base sottotop : mm 500  
base filotop : mm 450  
profondità vasca : mm 50  
foro incasso : mm 370 x 430  
foro sottotop : mm 340 x 400  
foro filotop : manuale installazione  
piletta standard manuale

## filoquadra 39 x 45

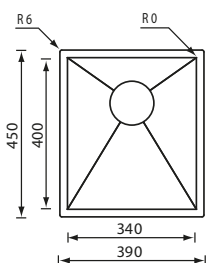

Optionals

1.5	2.3	2.12	2.13	2.14	3.2	3.18	3.19	4.6	4.15	5.6	5.7
-----	-----	------	------	------	-----	------	------	-----	------	-----	-----

5.9	5.10	5.11	6.6	7.6	11.1
-----	------	------	-----	-----	------

**011904.X0.01** satinato F3" slim cod. **07011342**

**011914.X0.01** satinato F3" sottotop cod. **07011362**

**011924.X0.01** satinato F3" filotop cod. **07011352**

base incasso : mm 450  
base sottotop : mm 500  
base filotop : mm 450  
profondità vasca : mm 190  
foro incasso : mm 370 x 430  
foro sottotop : mm 340 x 400  
foro filotop : manuale installazione  
piletta standard manuale

## filoquadra 57 x 45

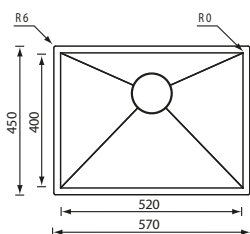

Optionals

1.5	2.3	2.12	2.13	2.14	3.2	3.18	3.19	4.6	4.16	5.6	5.7
-----	-----	------	------	------	-----	------	------	-----	------	-----	-----

5.9	5.10	5.11	6.6	7.6	11.1
-----	------	------	-----	-----	------

**011908.X0.01** satinato F3" slim cod. **07011344**

**011918.X0.01** satinato F3" sottotop cod. **07011364**

**011928.X0.01** satinato F3" filotop cod. **07011354**

base incasso : mm 600  
base sottotop : mm 800  
base filotop : mm 600  
profondità vasca : mm 190  
foro incasso : mm 550 x 430  
foro sottotop : mm 520 x 400  
foro filotop : manuale installazione  
piletta standard manuale

## filoquadra 77 x 45

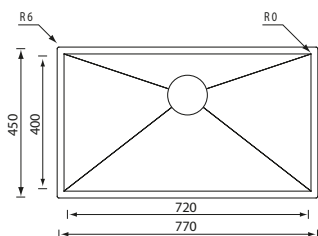

Optionals

1.5	2.3	2.12	2.13	2.14	3.2	3.18	3.19	4.6	4.17	5.6	5.7
-----	-----	------	------	------	-----	------	------	-----	------	-----	-----

5.9	5.10	5.11	6.6	7.6	11.1
-----	------	------	-----	-----	------

**011906.X0.01** satinato F3" slim cod. **07011346**

**011916.X0.01** satinato F3" sottotop cod. **07011366**

**011926.X0.01** satinato F3" filotop cod. **07011356**

base incasso : mm 800  
base sottotop : mm 900  
base filotop : mm 800  
profondità vasca : mm 190  
foro incasso : mm 750 x 430  
foro sottotop : mm 720 x 400  
foro filotop : manuale installazione  
piletta standard manuale



## filoquadra 77 x 45 2V

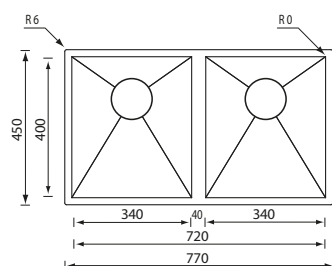

### Optionals

1.5	2.2	2.3	2.12	2.13	2.14	3.2	3.18	3.19	4.6	4.15	5.6
5.7	5.9	5.10	5.11	6.6	7.6	11.1					

**011909.X0.01** satinato F3" slim cod. **07011348**

**011919.X0.01** satinato F3" sottotop cod. **07011368**

**011929.X0.01** satinato F3" filotop cod. **07011358**

base incasso : mm 800  
 base sottotop : mm 900  
 base filotop : mm 800  
 profondità vasche : mm 190  
 foro incasso : mm 750 x 430  
 foro sottotop : mm 720 x 400  
 foro filotop : manuale installazione  
 piletta standard manuale



# FILOQUADRA MIX

## filoquadra mix 45 x 50

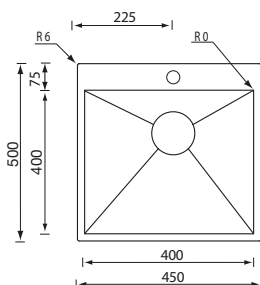

**012931.X1.01** satinato F3" slim cod. **07011381**

base : mm 500  
 profondità vasca : mm 190  
 foro incasso : mm 430 x 480  
 piletta standard manuale

Optionals

1.5	2.3	2.12	2.13	2.14	3.2	3.18	3.19	4.6	4.15	5.6	5.7
5.9	5.10	5.11	6.6	7.6	11.1						

## filoquadra mix 57 x 50

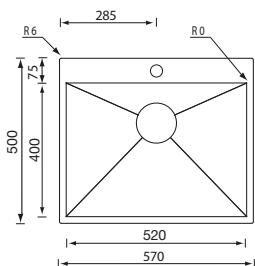

**012938.X1.01** satinato F3" slim cod. **07011382**

base : mm 600  
 profondità vasca : mm 190  
 foro incasso : mm 550 x 480  
 piletta standard manuale

Optionals

1.5	2.3	2.12	2.13	2.14	3.2	3.18	3.19	4.6	4.16	5.6	5.7
5.9	5.10	5.11	6.6	7.6	11.1						

## filoquadra mix 77 x 50

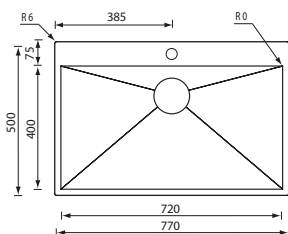

**012936.X1.01** satinato F3" slim cod. **07011384**

base : mm 800  
 profondità vasca : mm 190  
 foro incasso : mm 750 x 480  
 piletta standard manuale

Optionals

1.5	2.3	2.12	2.13	2.14	3.2	3.18	3.19	4.6	4.17	5.6	5.7
5.9	5.10	5.11	6.6	7.6	11.1						

## filoquadra mix 77 x 50 2V

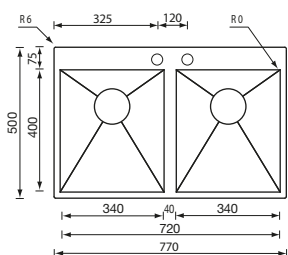

**012939.X2.01** satinato F3" slim cod. **07011386**

base : mm 800  
 profondità vasche : mm 190  
 foro incasso : mm 750 x 480  
 piletta standard automatica con comando quadro

Optionals

1.5	2.2	2.3	2.12	2.13	2.14	3.2	3.18	3.19	4.6	4.15	5.6
5.7	5.9	5.10	5.11	6.6	7.6	11.1					



### filoquadra mix 79 x 50 2V

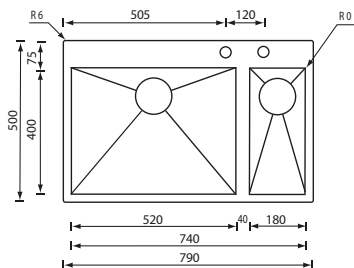

Optionals

1.5	2.2	2.3	2.12	2.13	2.14	3.2	3.8	3.18	3.19	4.6	4.16
5.6	5.7	5.9	5.10	5.11	6.6	7.6	11.1				

**012937.D2.01** satinato F3" slim dx cod. **070113871**

**012937.S2.01** satinato F3" slim sx cod. **070113872**

base : mm 900  
 profondità vasche : mm 190 - 130  
 foro incasso : mm 770 x 480  
 versione DX e SX  
 piletta standard automatica con comando quadro

### filoquadra mix 85 x 50

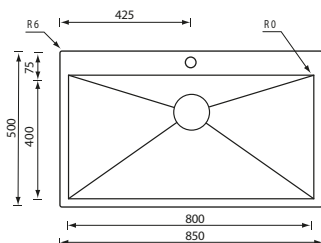

Optionals

1.5	2.3	2.12	2.13	2.14	3.2	3.18	3.19	4.6	4.17	5.6	5.7
5.9	5.10	5.11	6.6	7.6	11.1						

**012940.X1.01** satinato F3" slim cod. **07011388**

base : mm 900  
 profondità vasca : mm 190  
 foro incasso : mm 830 x 480  
 piletta standard manuale

### filoquadra mix 83 x 83 2V

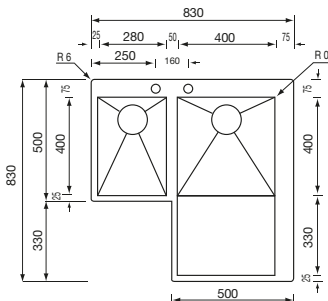

Optionals

1.5	2.2	2.3	2.12	2.13	2.14	3.2	3.18	3.19	4.6	4.15	5.6
5.7	5.9	5.10	5.11	6.6	7.6	11.1					

**012968.D2.01** satinato F3" slim dx cod. **07021091**

**012968.S2.01** satinato F3" slim sx cod. **07021092**

base : mm 900  
 profondità vasche : mm 190  
 foro incasso : manuale installazione  
 versione DX e SX  
 piletta standard automatica con comando quadro

# FILOQUADRA MIX

## filoquadra mix 86 x 50 1V

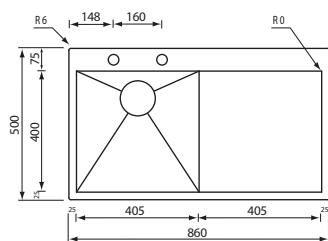

**012960.D2.01** satinato F3" slim dx cod. **07011411**

**012960.S2.01** satinato F3" slim sx cod. **07011412**

base mm 450 / mm 500 se inizio composizione  
base : mm 900 per piano inferiore 30 mm  
profondità vasca : mm 190  
foro incasso : mm 840 x 480  
versione DX e SX  
piletta standard automatica con comando quadro

### Optionals

1.5 | 2.3 | 2.12 | 2.13 | 2.14 | 3.2 | 3.18 | 3.19 | 4.6 | 4.15 | 5.6 | 5.7

5.9 | 5.10 | 5.11 | 6.6 | 7.6 | 11.1

## filoquadra mix 100 x 50 1V

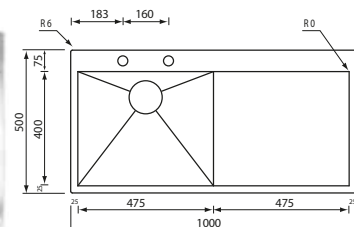

**012961.D2.01** satinato F3" slim dx cod. **07011421**

**012961.S2.01** satinato F3" slim sx cod. **07011422**

base mm 600  
base : mm 1200 per piano inferiore 30 mm  
profondità vasca : mm 190  
foro incasso : mm 980 x 480  
versione DX e SX  
piletta standard automatica con comando quadro

### Optionals

1.5 | 2.3 | 2.12 | 2.13 | 2.14 | 3.2 | 3.18 | 3.19 | 4.6 | 4.16 | 5.6 | 5.7

5.9 | 5.10 | 5.11 | 6.6 | 7.6 | 11.1

## filoquadra mix 100 x 50 + 2 SCIIV

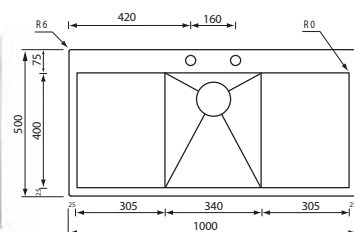

**012965.X2.01** satinato F3" slim cod. **07011420**

base : mm 450 / mm 800 se inizio composizione  
base : mm 1200 per piano inferiore 30 mm  
profondità vasca : mm 190  
foro incasso : mm 980 x 480  
piletta standard automatica con comando quadro

### Optionals

1.5 | 2.3 | 2.12 | 2.13 | 2.14 | 3.2 | 3.18 | 3.19 | 4.6 | 4.15 | 5.6 | 5.7

5.9 | 5.10 | 5.11 | 6.6 | 7.6 | 11.1

## filoquadra mix 100 x 50 2V mm 380/190

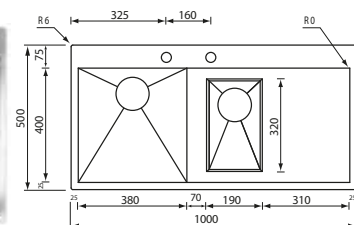

**012962.D2.01** satinato F3" slim dx cod. **07011431**

**012962.S2.01** satinato F3" slim sx cod. **07011432**

base : mm 800  
base : mm 1200 per piano inferiore 30 mm  
profondità vasche : mm 190 - 130  
foro incasso : mm 980 x 480  
versione DX e SX  
piletta standard automatica con comando quadro

### Optionals

1.5 | 2.3 | 2.12 | 2.13 | 2.14 | 3.2 | 3.4 | 3.18 | 3.19 | 4.6 | 4.15 | 5.6

5.7 | 5.9 | 5.10 | 5.11 | 6.6 | 7.6 | 11.1

**filoquadra mix 100 x 50 2V**  
mm 340/160

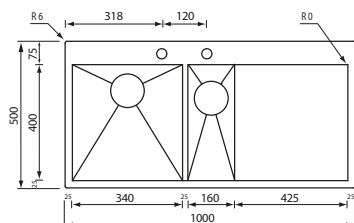

**012964.D2.01** satinato F3" slim dx cod. **07011435**

**012964.S2.01** satinato F3" slim sx cod. **07011436**

base: mm 600  
base : mm 1200 per piano inferiore 30 mm  
profondità vasche : mm 190 - 130  
foro incasso : mm 980 x 480  
versione DX e SX  
piletta standard automatica con comando quadro

Optionals

1.5	2.3	2.12	2.13	2.14	3.2	3.18	3.19	4.6	4.15	5.6	5.7
5.9	5.10	5.11	6.6	7.6	11.1						

**filoquadra mix 116 x 50 1V + 2 SCIV**

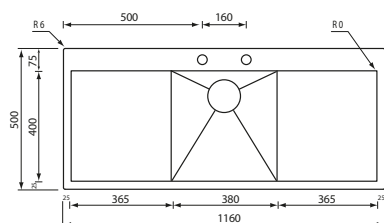

**012966.X2.01** satinato F3" slim cod. **07011440**

base: mm 450/mm 900 se inizio composizione  
base: mm 1200 per piano inferiore 30 mm  
profondità vasca : mm 190  
foro incasso : mm 1140 x 480  
piletta standard automatica con comando quadro

Optionals

1.5	2.3	2.12	2.13	2.14	3.2	3.18	3.19	4.6	4.15	5.6	5.7
5.9	5.10	5.11	6.6	7.6	11.1						

**filoquadra mix 116 x 50 2V**

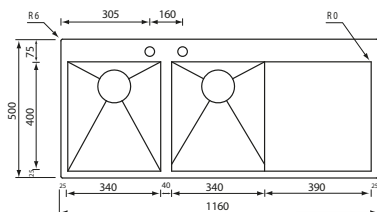

**012963.D2.01** satinato F3" slim dx cod. **07011441**

**012963.S2.01** satinato F3" slim sx cod. **07011442**

base: mm 800  
base: mm 1200 per piano inferiore 30 mm  
profondità vasche : mm 190  
foro incasso: mm 1140 x 480  
versione DX e SX  
piletta standard automatica con comando quadro

Optionals

1.5	2.2	2.3	2.12	2.13	2.14	3.2	3.18	3.19	4.6	4.15	5.6
5.7	5.9	5.10	5.11	6.6	7.6	11.1					

# ENEAA

## enea 86 x 51 1V mm 340x365

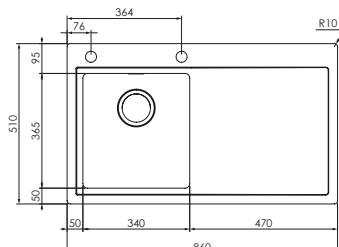

### Optionals

2.11 | 3.16 | 4.8 | 5.5 | 11.1

**017100.D2.01** satinato F3" slim dx cod. **07021101**

**017100.S2.01** satinato F3" slim sx cod. **07021102**

**017100.D2.01** satinato F3" filotop dx cod. **07021151**

**017100.S2.01** satinato F3" filotop sx cod. **07021152**

base incasso-filotop : mm 450 / mm 500 se inizio composizione

profondità vasca : mm 200

foro incasso : mm 840 x 490

foro filotop : manuale installazione

versione DX e SX

piletta rondò automatica con comando easy

## enea 86 x 51 1V mm 400x365

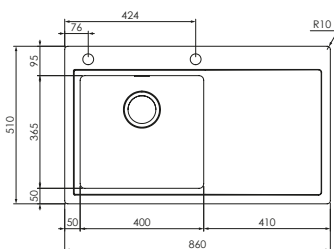

### Optionals

2.11 | 3.16 | 4.8 | 5.5 | 11.1

**017101.D2.01** satinato F3" slim dx cod. **07021111**

**017101.S2.01** satinato F3" slim sx cod. **07021112**

**017101.D2.01** satinato F3" filotop dx cod. **07021161**

**017101.S2.01** satinato F3" filotop sx cod. **07021162**

base incasso-filotop : mm 450 / mm 600 se inizio composizione

profondità vasca : mm 200

foro incasso : mm 840 x 490

foro filotop : manuale installazione

versione DX e SX

piletta rondò automatica con comando easy

## enea 100 x 51 1V mm 400x365

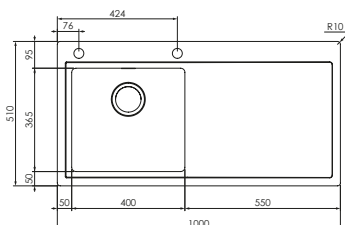

### Optionals

2.11 | 3.16 | 4.8 | 5.5 | 11.1

**017102.D2.01** satinato F3" slim dx cod. **07021121**

**017102.S2.01** satinato F3" slim sx cod. **07021122**

**017102.D2.01** satinato F3" filotop dx cod. **07021171**

**017102.S2.01** satinato F3" filotop sx cod. **07021172**

base incasso-filotop : mm 450 / mm 600 se inizio composizione

profondità vasca : mm 200

foro incasso : mm 980 x 490

foro filotop : manuale installazione

versione DX e SX

piletta rondò automatica con comando easy

## enea 100 x 51 1V mm 500x365

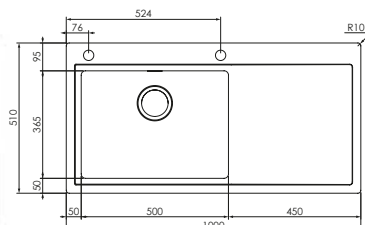

### Optionals

2.11 | 3.16 | 4.8 | 5.5 | 11.1

**017103.D2.01** satinato F3" slim dx cod. **07021131**

**017103.S2.01** satinato F3" slim sx cod. **07021132**

**017103.D2.01** satinato F3" filotop dx cod. **07021181**

**017103.S2.01** satinato F3" filotop sx cod. **07021182**

base incasso-filotop : mm 600 / mm 800 se inizio composizione

profondità vasca : mm 200

foro incasso : mm 980 x 490

foro filotop : manuale installazione

versione DX e SX

piletta rondò automatica con comando easy

**enea 116 x 51 2V**

**017104.D2.01** satinato F3" slim dx cod. **07021141**

**017104.S2.01** satinato F3" slim sx cod. **07021142**

**017104.D2.01** satinato F3" filotop dx cod. **07021191**

**017104.S2.01** satinato F3" filotop sx cod. **07021192**

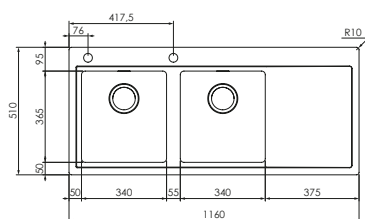

base incasso-filotop : mm 800 / mm 900 se inizio composizione

profondità vasche : mm 200

foro incasso : mm 1140 x 490

foro filotop : manuale installazione

versione DX e SX

pielletta rondò automatica con comando easy

Optionals

2.11 | 3.16 | 4.8 | 5.5 | 11.1



# VESTA

## vesta 86 x 50 1V

**010803.X2.01** satinato F3" standard cod. **07011310**

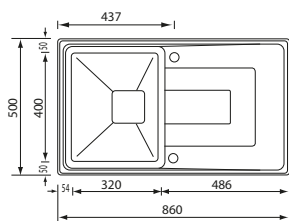

base : mm 500 / mm 600 se inizio composizione  
 profondità vasca: mm 210  
 foro incasso : mm 835 x 475  
 versione reversibile  
 piletta quadra automatica con comando quadro

Optionals

2.3 | 2.13 | 2.14 | 3.5 | 5.6 | 5.7 | 5.9 | 5.10 | 5.11 | 6.3 | 7.4 | 11.1

## vesta 86 x 50 2V

**010804.X2.01** satinato F3" standard cod. **07011312**

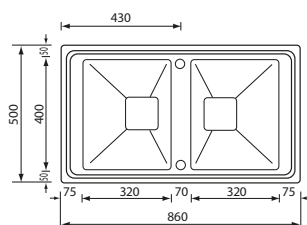

base : mm 800 / mm 900 se inizio composizione  
 profondità vasche : mm 210  
 foro incasso : mm 835 x 475  
 piletta quadra automatica con comando quadro

Optionals

2.3 | 2.13 | 2.14 | 3.5 | 5.6 | 5.7 | 5.9 | 5.10 | 5.11 | 6.3 | 7.4 | 11.1

## vesta 100 x 50 1V

**010806.X2.01** satinato F3" standard cod. **07011316**

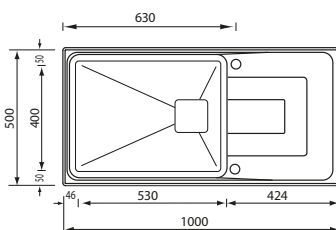

base : mm 800  
 profondità vasca: mm 210  
 foro incasso : mm 975 x 475  
 versione reversibile  
 piletta quadra automatica con comando quadro

Optionals

1.5 | 2.3 | 2.13 | 2.14 | 3.5 | 5.6 | 5.7 | 5.9 | 5.10 | 5.11 | 6.3 | 7.4  
 11.1

## vesta 100 x 50 2V

**010805.X2.01** satinato F3" standard cod. **07011314**

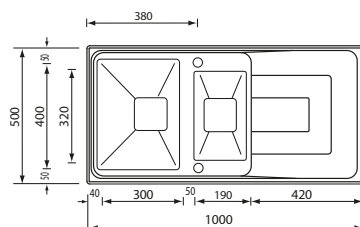

base : mm 600 / mm 800 se inizio composizione  
 profondità vasche : mm 210 - 140  
 foro incasso : mm 975 x 475  
 versione reversibile  
 piletta quadra automatica con comando quadro

Optionals

2.3 | 2.13 | 2.14 | 3.4 | 3.6 | 5.6 | 5.7 | 5.9 | 5.10 | 5.11 | 6.3 | 7.4  
 11.1



**vesta 116 x 50 2V**

**010807.X2.01** satinato F3" standard cod. **07011318**

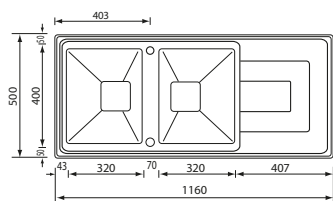

base : mm 800 / mm 900 se inizio composizione  
profondità vasche: mm 210  
foro incasso: mm 1135 x 475  
versione reversibile  
piletta quadra automatica con comando quadro

Optionals

2.3 | 2.13 | 2.14 | 3.5 | 5.6 | 5.7 | 5.9 | 5.10 | 5.11 | 6.3 | 7.4 | 11.1



# EVOLUZIONE

## evoluzione 86 x 50 1V

**015003.X2.01** satinato F3" slim cod. **07011293**

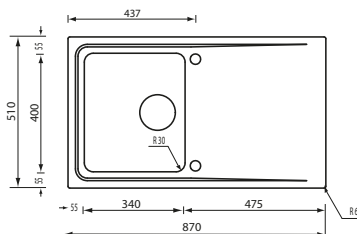

base : mm450/mm500 se inizio composizione  
 profondità vasca : mm 195  
 foro slim : mm 850 x 490  
 versione reversibile  
 piletta rondò automatica con comando quadro

Optionals

1.1 | 2.3 | 2.13 | 2.14 | 4.4 | 5.6 | 5.7 | 5.9 | 5.10 | 5.11 | 11.1

## evoluzione 100 x 50 1V

**015006.X2.01** satinato F3" slim cod. **07011295**

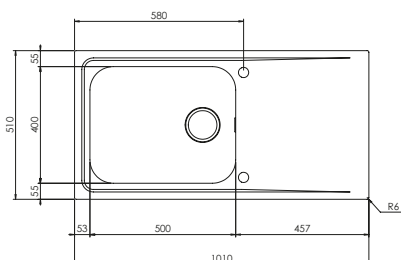

base : mm600/mm800 se inizio composizione  
 profondità vasca : mm 205  
 foro slim : mm 990 x 490  
 versione reversibile  
 piletta rondò automatica con comando quadro

Optionals

1.5 | 2.3 | 2.13 | 2.14 | 4.4 | 5.6 | 5.7 | 5.9 | 5.10 | 5.11 | 11.1

## evoluzione 100 x 50 2V

**015005.X2.01** satinato F3" slim cod. **07011294**

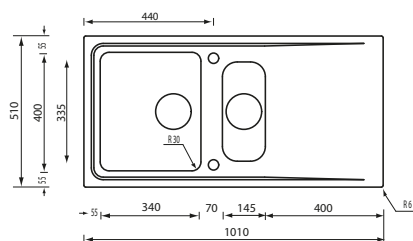

base : mm600/mm800 se inizio composizione  
 profondità vasche : mm 195 - 130  
 foro slim : mm 990 x 490  
 versione reversibile  
 piletta rondò automatica con comando quadro

Optionals

1.1 | 2.1 | 2.3 | 2.13 | 2.14 | 4.3 | 4.4 | 5.6 | 5.7 | 5.9 | 5.10 | 5.11

11.1

## evoluzione 116 x 50 2V

**015007.X2.01** satinato F3" slim cod. **07011297**

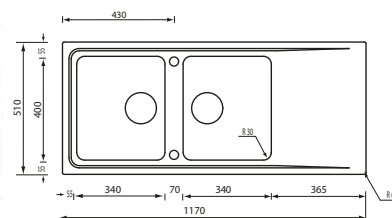

base : mm 800/mm900 se inizio composizione  
 profondità vasche : mm 195  
 foro slim : mm 1150 x 490  
 versione reversibile  
 piletta rondò automatica con comando quadro

Optionals

1.1 | 2.3 | 2.13 | 2.14 | 4.4 | 5.6 | 5.7 | 5.9 | 5.10 | 5.11 | 11.1



# BRANDO

## brando 86 x 50 1V

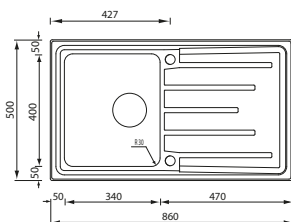

Optionals

1.1 | 2.3 | 2.13 | 2.14 | 4.4 | 5.6 | 5.7 | 5.9 | 5.10 | 5.11 | 6.3 | 7.4

11.1

**015103.X2.01** satinato F3" standard cod. **07015711**

base: mm 450 / mm 500 se inizio composizione  
base: mm 900 per piano inferiore 30 mm  
profondità vasca : mm 210  
foro incasso : mm 835 x 475  
versione reversibile  
piletta rondò automatica con comando quadro

## brando 86 x 50 2V

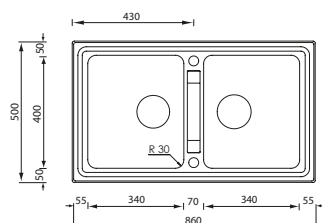
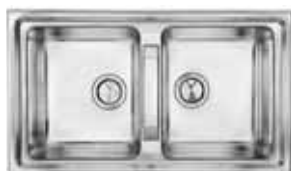

Optionals

1.1 | 2.3 | 2.13 | 2.14 | 4.4 | 5.6 | 5.7 | 5.9 | 5.10 | 5.11 | 6.3 | 7.4

11.1

**015104.X2.01** satinato F3" standard cod. **07015710**

base: mm 800 / mm 900 se inizio composizione  
profondità vasche: mm 210  
foro incasso : mm 835 x 475  
piletta rondò automatica con comando quadro

## brando 100 x 50 2V

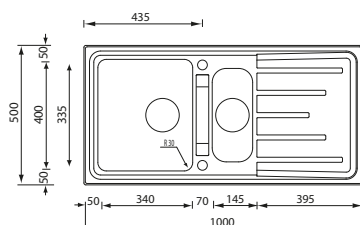

Optionals

1.1 | 2.1 | 2.3 | 2.13 | 2.14 | 4.3 | 4.4 | 5.6 | 5.7 | 5.9 | 5.10 | 5.11

6.3 | 7.4 | 11.1

**015105.X2.01** satinato F3" standard cod. **07015721**

base: mm 600 / mm 800 se inizio composizione  
base: mm 1200 per piano inferiore 30 mm  
profondità vasche : mm 210 - 140  
foro incasso : mm 975 x 475  
versione reversibile  
piletta rondò automatica con comando quadro

## brando 116 x 50 2V

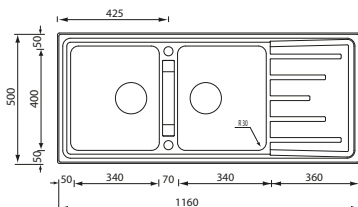

Optionals

1.1 | 2.3 | 2.13 | 2.14 | 4.4 | 5.6 | 5.7 | 5.9 | 5.10 | 5.11 | 6.3 | 7.4

11.1

**015107.X2.01** satinato F3" standard cod. **07015741**

base: mm 800 / mm 900 se inizio composizione  
base : mm 1200 per piano inferiore 30 mm  
profondità vasche: mm 210  
foro incasso : mm 1135 x 475  
versione reversibile  
piletta rondò automatica con comando quadro







# PUNTO QUADRO

## punto quadro 86 x 50 1V

**010903.X2.01** satinato F3" standard cod. **07014905**

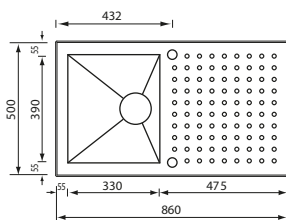

base : mm 500 / mm 600 se inizio composizione  
 profondità vasca: mm 190  
 foro incasso : mm 835 x 475  
 versione reversibile  
 piletta standard automatica con comando quadro

### Optionals

2.4 | 3.3 | 4.6 | 6.6 | 7.6 | 11.1

## punto quadro 86 x 50 2V

**010904.X2.01** satinato F3" standard cod. **07014910**

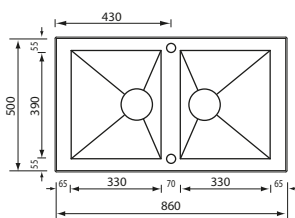

base : mm 800 / mm 900 se inizio composizione  
 profondità vasche : mm 190  
 foro incasso : mm 835 x 475  
 piletta standard automatica con comando quadro

### Optionals

2.4 | 3.3 | 4.6 | 6.6 | 7.6 | 11.1

## punto quadro 100 x 50 1V

**010906.X2.01** satinato F3" standard cod. **07015005**

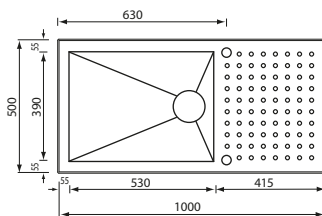

base : mm 800  
 profondità vasca : mm 190  
 foro incasso : mm 975 x 475  
 versione reversibile  
 piletta standard automatica con comando quadro

### Optionals

2.4 | 3.3 | 4.6 | 6.6 | 7.6 | 11.1

## punto quadro 100 x 50 2V

**010905.X2.01** satinato F3" standard cod. **07015015**

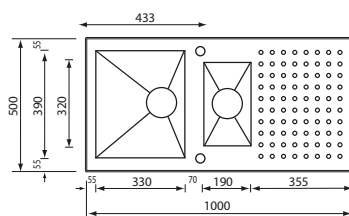

base : mm 800  
 profondità vasche : mm 190 - 130  
 foro incasso : mm 975 x 475  
 versione reversibile  
 piletta standard automatica con comando quadro

### Optionals

2.4 | 3.3 | 3.4 | 4.6 | 6.6 | 7.6 | 11.1

**punto quadro 116 x 50 2V**

**010907.X2.01** satinato F3" standard cod. **07016215**

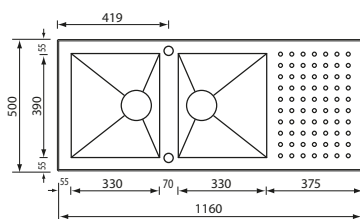

base : mm 800 / mm 900 se inizio composizione  
profondità vasche: mm 190  
foro incasso: mm 1135 x 475  
versione reversibile  
piletta standard automatica con comando quadro

Optionals

2.4 | 3.3 | 4.6 | 6.6 | 7.6 | 11.1



# LUCE

## luce 44x44

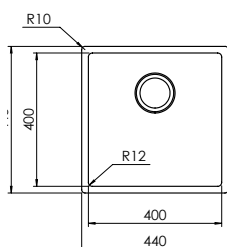

Optionals

1.5	2.12	2.13	2.14	3.18	3.19	4.6	5.6	5.7	5.9	5.10	6.6
7.6	11.1										

## luce 54x44

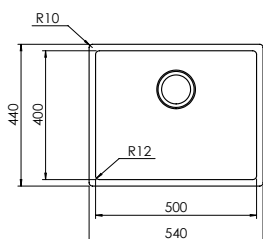

Optionals

1.5	2.12	2.13	2.14	3.18	3.19	4.6	5.6	5.7	5.9	5.10	6.6
7.6	11.1										

## luce 74x44

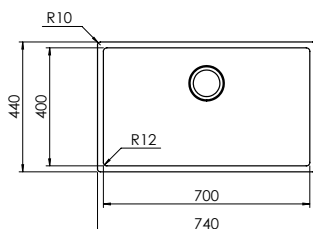

Optionals

1.5	2.12	2.13	2.14	3.18	3.19	4.6	5.6	5.7	5.9	5.10	6.6
7.6	11.1										

## luce 74,5x44 2V

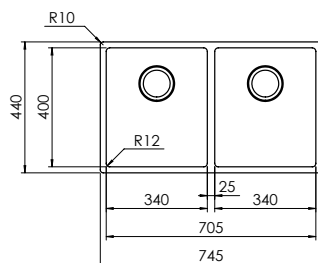

Optionals

1.5	2.12	2.13	2.14	3.18	3.19	4.6	5.6	5.7	5.9	5.10	6.6
7.6	11.1										

**052001** satinato F3" sottotop cod. **07016461**

**052051** satinato F3" slim cod. **07016441**

**052051** satinato F3" filotop cod. **07016451**

base incasso: mm 500  
base sottotop: mm 600  
base filotop: mm 500  
profondità vasca: mm 180  
foro incasso: mm 430 x 430  
foro sottotop : mm 400 x 400 R12  
foro filotop : manuale installazione  
con piletta manuale

**052002** satinato F3" sottotop cod. **07016464**

**052052** satinato F3" slim cod. **07016444**

**052052** satinato F3" filotop cod. **07016454**

base incasso: mm 600  
base sottotop : mm 800  
base filotop : mm 600  
profondità vasca: mm 180  
foro incasso : mm 530 x 430  
foro sottotop : mm 500 x 400 R12  
foro filotop : manuale installazione  
con piletta manuale

**052003** satinato F3" sottotop cod. **07016466**

**052053** satinato F3" slim cod. **07016446**

**052053** satinato F3" filotop cod. **07016456**

base incasso : mm 800  
base sottotop : mm 900  
base filotop : mm 800  
profondità vasca : mm 180  
foro incasso : mm 730 x 430  
foro sottotop : mm 700 x 400 R12  
foro filotop : manuale installazione  
con piletta manuale

**052004** satinato F3" sottotop cod. **07016467**

**052054** satinato F3" slim cod. **07016447**

**052054** satinato F3" filotop cod. **07016457**

base incasso : mm 800  
base sottotop : mm 900  
base filotop : mm 800  
profondità vasche : mm 180  
foro incasso : mm 735 x 430  
foro sottotop : mm 705 x 400 R12  
foro filotop : manuale installazione  
con piletta manuale

# LUCE MIX

## luce mix 45x51

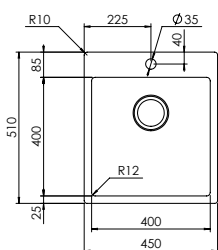

Optionals

1.5	2.12	2.13	2.14	3.18	3.19	4.6	5.6	5.7	5.9	5.10	6.6
7.6	11.1										

**052041** satinato F3" slim cod. **07016481**

**052041** satinato F3" filotop cod. **07016491**

base incasso: mm 500  
base filotop: mm 500  
profondità vasca: mm 180  
foro incasso: mm 435 x 495  
foro filotop : manuale installazione  
con piletta manuale

## luce mix 55x51

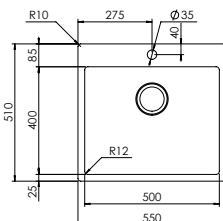

Optionals

1.5	2.12	2.13	2.14	3.18	3.19	4.6	5.6	5.7	5.9	5.10	6.6
7.6	11.1										

**052042** satinato F3" slim cod. **07016483**

**052042** satinato F3" filotop cod. **07016493**

base incasso: mm 600  
base filotop: mm 600  
profondità vasca: mm 180  
foro incasso: mm 535 x 495  
foro filotop : manuale installazione  
con piletta manuale

## luce mix 75x51

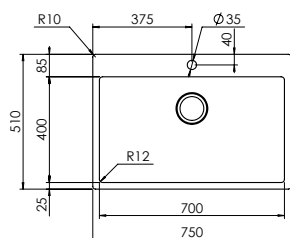

Optionals

1.5	2.12	2.13	2.14	3.18	3.19	4.6	5.6	5.7	5.9	5.10	6.6
7.6	11.1										

**052043** satinato F3" slim cod. **07016486**

**052043** satinato F3" filotop cod. **07016496**

base incasso: mm 800  
base filotop: mm 800  
profondità vasca: mm 180  
foro incasso: mm 735 x 495  
foro filotop : manuale installazione  
con piletta manuale

## luce mix 75,5x51 2V

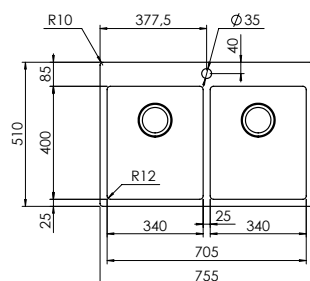

Optionals

1.5	2.12	2.13	2.14	3.18	3.19	4.6	5.6	5.7	5.9	5.10	6.6
7.6	11.1										

**052044** satinato F3" slim cod. **07016487**

**052044** satinato F3" filotop cod. **07016497**

base incasso: mm 800  
base filotop: mm 800  
profondità vasche: mm 180  
foro incasso: mm 740 x 495  
foro filotop : manuale installazione  
con piletta manuale

# Optionals **LUXURY**STYLE

<p><b>1.1</b></p>  <p><b>092000</b> cod. 08711860 mm 342 x 410 vassoio in ABS bianco</p>	<p><b>1.5</b></p>  <p><b>092013</b> cod. 08711916A mm 420 x 300 economizzatore d'acqua in PPMA</p>	<p><b>2.1</b></p>  <p><b>092020</b> cod. 08711870 mm 335 x 145 vaschetta inox forata</p>
<p><b>2.2</b></p>  <p><b>092025</b> cod. 08711871 mm 343 x 222 vaschetta inox forata</p>	<p><b>2.3</b></p>  <p><b>092031</b> cod. 08711874 mm 410 x 230 vaschetta inox forata</p>	<p><b>2.4</b></p>  <p><b>092032</b> cod. 08711875 mm 400 x 230 vaschetta inox forata</p>
<p><b>2.5</b></p>  <p><b>092037</b> cod. 08711879 mm 390 x 230 vaschetta inox forata</p>	<p><b>2.6</b></p>  <p><b>092039</b> cod. 08711878 mm 330 x 390 vaschetta inox colapasta</p>	<p><b>2.7</b></p>  <p><b>092041</b> cod. 08711877 mm 405 x 230 vaschetta inox forata</p>
<p><b>2.8</b></p>  <p><b>092042</b> cod. 08711876 mm 310 x 310 vaschetta inox forata</p>	<p><b>2.9</b></p>  <p><b>092047</b> cod. 08711869 mm 410 x 290 vaschetta inox forata</p>	<p><b>2.10</b></p>  <p><b>092049</b> cod. 08711867 mm 350 x 230 vaschetta inox forata</p>
<p><b>2.11</b></p>  <p><b>092056</b> cod. 08711881 mm 375 x 230 vaschetta inox forata</p>	<p><b>2.12</b></p>  <p><b>092058</b> cod. 08711882 mm 435 x 200 vaschetta inox forata</p>	<p><b>2.13</b></p>  <p><b>092065</b> cod. 08711883 mm 410 x 280 h.70 vaschetta inox forata con scolapiatti</p>
<p><b>2.14</b></p>  <p><b>092066</b> cod. 08711884 mm 410 x 280 h.70 vaschetta inox forata</p>	<p><b>3.2</b></p>  <p><b>092023</b> cod. 08711847 mm 340 x 400 vassoio inox forato</p>	<p><b>3.3</b></p>  <p><b>092027</b> cod. 08711849 mm 330 x 390 vassoio inox forato</p>
<p><b>3.4</b></p>  <p><b>092028</b> cod. 08711853 mm 320 x 190 vassoio inox forato</p>	<p><b>3.5</b></p>  <p><b>092029</b> cod. 08711851 mm 320 x 400 vassoio inox forato</p>	<p><b>3.6</b></p>  <p><b>092030</b> cod. 08711852 mm 300 x 400 vassoio inox forato</p>
<p><b>3.7</b></p>  <p><b>092036</b> cod. 08711858 mm 335 x 380 vassoio inox forato</p>	<p><b>3.8</b></p>  <p><b>092038</b> cod. 08711854 mm 180 x 400 vassoio inox forato</p>	<p><b>3.9</b></p>  <p><b>092040</b> cod. 08711857 mm 400 x 400 vassoio inox forato</p>



3.10



**092043**  
cod. 08711856  
mm 380 x 450  
vassoio inox forato

3.11



**092046**  
cod. 08711868  
mm 410 x 400  
vassoio inox forato

3.12



**092051**  
cod. 08711862  
mm 350 x 350  
vassoio inox forato

3.13



**092044**  
cod. 08711890  
mm 353 x 402  
vassoio inox forato

3.16



**092057**  
cod. 08711864  
mm 340 x 365  
vassoio inox forato

3.18

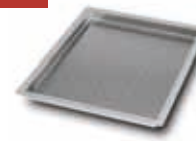

**092062**  
cod. 08711891  
mm 370 x 435  
vassoio inox forato

3.19



**092059**  
cod. 08711892  
mm 200 x 435  
vassoio inox forato

4.1



**093001**  
cod. 08711920  
mm 380 x 450  
cestello inox

4.2



**093002**  
cod. 08711899  
mm 320 x 410  
cestello inox

4.3



**093041**  
cod. 08711908  
mm 335 x 145  
cestello inox

4.4



**093080**  
cod. 08711906  
mm 400 x 325  
cestello inox

4.6



**093100**  
cod. 08711904  
mm 330 x 390  
cestello inox

4.8



**093102**  
cod. 08711900  
mm 340 x 350  
cestello inox

4.15

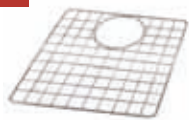

**093005**  
cod. 08711930  
mm 310 x 315  
griglia inox fondo vasca

4.16

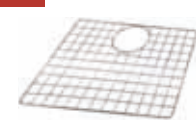

**093006**  
cod. 08711930A  
mm 425 x 340  
griglia inox fondo vasca

4.17

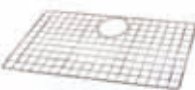

**093007**  
cod. 08711930B  
mm 630 x 340  
griglia inox fondo vasca

5.1



**094090**  
cod. 08711863  
mm 370 x 400  
tagliere PE

5.5



**094094**  
cod. 08711865  
mm 320 x 380  
tagliere PE bianco

5.6



**094095**  
cod. 08711865A  
mm 420 x 320  
tagliere PE bianco

5.7



**094096**  
cod. 08711865B  
mm 250 x 415  
tagliere/copri vasca  
HPL nero

5.9



**094097**  
cod. 08711865C  
mm 250 x 415  
griglia appoggio HPL nero

5.10



**094098**  
cod. 08711865D  
mm 50 x 415  
n°2 barre multiuso  
HPL nero

5.11



**092064**  
cod. 08711880A  
mm 410 x 280  
vassoio inox forato con  
tagliere HPL nero

6.2



**094006\***  
cod. 08711829  
mm 270 x 450  
tagliere iroko

# Optionals **LUXURY**STYLE

<b>6.3</b>	 <p><b>094020</b> cod. 08711807 prof. mm 500 tagliere scorrevole iroko</p>	<b>6.4</b>	 <p><b>094051</b> cod. 08711840 mm 335 x 380 tagliere iroko</p>	<b>6.5</b>	 <p><b>094062</b> cod. 08711809 prof. mm 510 tagliere scorrevole iroko</p>
------------	---	------------	--	------------	---

<b>6.6</b>	 <p><b>094073</b> cod. 08711808 mm 330 x 390 tagliere iroko</p>	<b>7.1</b>	 <p><b>094007*</b> cod. 08711830 mm 270 x 450 tagliere iroko con inserto PE</p>	<b>7.2</b>	 <p><b>094013</b> cod. 08711837 mm 400 x 400 tagliere iroko con inserto PE</p>
------------	--	------------	--	------------	---

<b>7.3</b>	 <p><b>094015</b> cod. 08711839 mm 487 x 447 tagliere iroko con inserto PE</p>	<b>7.4</b>	 <p><b>094021</b> cod. 08711816 prof. mm 500 tagliere scorrevole iroko con inserto PE</p>	<b>7.5</b>	 <p><b>094064</b> cod. 08711819 prof. mm 510 tagliere scorrevole iroko con inserto PE</p>
------------	---	------------	--	------------	--

<b>7.6</b>	 <p><b>094071</b> cod. 08711815 mm 330 x 390 tagliere iroko con inserto PE</p>	<b>8.1</b>	 <p><b>094009*</b> cod. 08711835 mm 270 x 450 tagliere iroko con vaschetta inox forata</p>	<b>9.2</b>	 <p><b>094054</b> cod. 08711843 mm 335 x 380 tagliere iroko con colabicchieri inox</p>
------------	--	------------	--	------------	--

<b>11.1</b>	 <p><b>093004</b> cod. 08711929 mm470x450 tappetino inox arrotolabile</p>
-------------	--



Optionals **LUXURY**STYLE

# GIADA

## BLOCCO LAVELLO

giada 90 x 65 2V mm 530x400 + 205x400

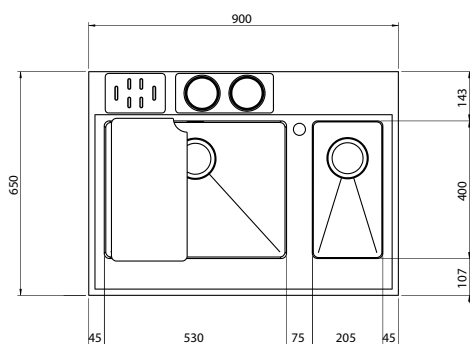
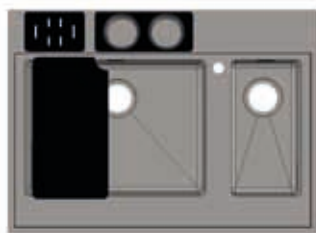

**C0500V000** 2VD satinato F3" cod. **07000811**  
**C0500V001** 2VS satinato F3" cod. **07000812**

base : mm 900  
profondità vasche : mm 210/150  
profondità invaso: mm 20  
altezza fascia: mm 180  
piletta rondò manuale  
mm 900x650x180 disponibile versione DX - SX

n°2 Vasche 530x400 R15  
205x400 R15

N.B. Il verso del lavello è dettato dalla posizione della vasca grande

## BLOCCO LAVELLO

giada 120 x 65 2V mm 720x400 + 205x400

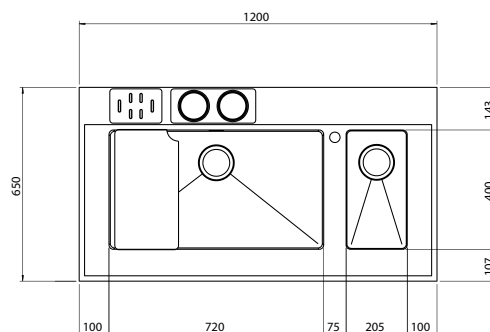
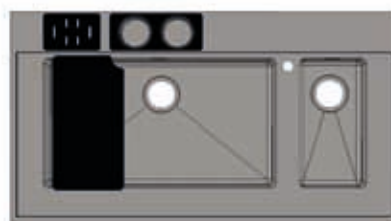

**C0500V002** 2VD satinato F3" cod. **07000821**  
**C0500V003** 2VS satinato F3" cod. **07000822**

base : mm 1200  
profondità vasche : mm 210/150  
profondità invaso: mm 20  
altezza fascia : mm 180  
piletta rondò manuale  
mm 1200x650x180 disponibile versione DX - SX

n°2 Vasche 720x400 R15  
205x400 R15

N.B. Il verso del lavello è dettato dalla posizione della vasca grande

## ACCESSORI DI SERIE



### n°2 Bicchieri Porta posate

base nera in HPL  
bicchieri Ø 94 in acciaio inox



### n°1 Portacoltelli

base nera in HPL  
mm 175 x 115



### n°1 Tagliere per lavello

nero in HPL  
mm 220 x 415

In aggiunta è disponibile anche il dispenser cod. 091002 v.di componenti.



**BLOCCO PIANO COTTURA**  
giada 90 x 65

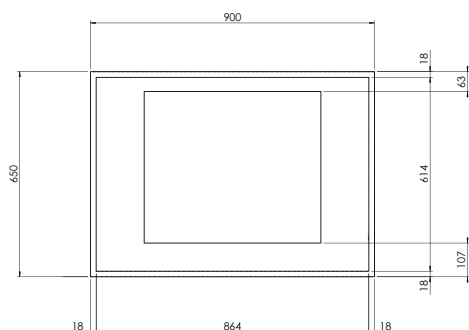

**C0500T001** satinato cod. **07000825**

N.B. È possibile inserire piani cottura fino ad una larghezza max di 75 cm

base : mm 900  
 predisposto con **foro piano cottura da incasso, compreso induzione**  
**non previste tipologie filotop e saldati**  
 profondità invaso: mm 20  
 altezza fascia: mm 180  
 mm 900x650x180

**BLOCCO PIANO COTTURA**  
giada 120 x 65

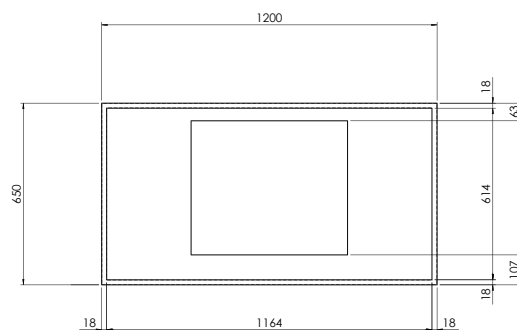

**C0500T002** satinato cod. **07000826**

N.B. È possibile inserire piani cottura fino ad una larghezza max di 92.5 cm

base : mm 1200  
 predisposto con **foro piano cottura da incasso, compreso induzione**  
**non previste tipologie filotop e saldati**  
 profondità invaso: mm 20  
 altezza fascia rivestita: mm 180  
 mm 1200x650x180





Linea  
**COLORSTYLE**

La nuova linea di lavelli Colorstyle lascia la possibilità di scegliere la gamma di colori, fra cooper bronze, gold, gun metal, disponibile in versione lucida e opaca. Iride si presenta pratico da usare, ma anche di notevole impatto estetico. Colori che regalano alla cucina un armonioso tocco di eleganza e originalità. Finiture di luce che esaltano la bellezza del lavello.

Realizzati in acciaio inox con trattamento PVD resistenti agli urti e agli shock termici, resistenti ai graffi e all'aggressione chimica, inalterabili alla luce, donano alla superficie un effetto ambiente unico.

**COOPER**



STYLE



# COLORSTYLE

## Finiture PVD

Il modello IRIDE é disponibile nelle tre colorazioni in versione lucida e opaca.



L29 - copper bronze



L79 - gold



L82 - gun metal



L29 - copper bronze MATT



L79 - gold MATT



L82 - gun metal MATT



L29-COPPER BRONZE



L79-GOLD



L29-COPPER BRONZE MATT



L79-GOLD MATT



L82-GUN METAL



PILETTA STANDARD MANUALE  
disponibile nelle varianti colore



L82-GUN METAL MATT

# Profili



## SLIM

Installarlo è facile come appoggiarlo, l'effetto è di praticità e leggerezza: solo il tatto scopre il piccolo bordo perimetrale. Eleganza e funzionalità in cucina.



## FILOTOP

Top e lavello perfettamente allineati creano un design essenziale. Bordo ultrapiatto e sistema d'aggancio avanzato: l'incasso è perfetto, minimale e rigoroso, pratico senza scomode sporgenze.

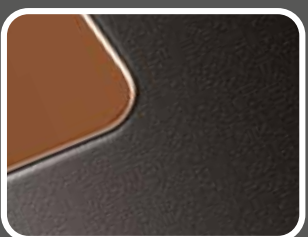

## SOTTOTOP

Sotto sotto c'è il lavello più innovativo, esclusivo e adatto alle soluzioni alternative. Per sfruttare al meglio gli spazi, forme rettangolari e circolari da fissare sotto il piano di lavoro.



## INDICE



70 ●● IRIDE



72 ●● IRIDE MATT

73 ●● Optionals

# IRIDE

## iride 45 x 45

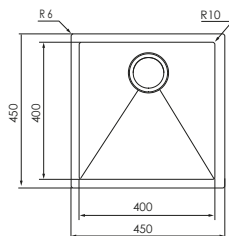

### Optionals

1.5	4.6	5.6	5.7	5.9	5.10	6.6	7.6	11.1
-----	-----	-----	-----	-----	------	-----	-----	------

<b>012252.L29.X0.01</b>	copper bronze F3" slim	cod. <b>07021301</b>
<b>012252.L29.X0.01</b>	copper bronze F3" sottotop	cod. <b>07021303</b>
<b>012252.L29.X0.01</b>	copper bronze F3" filotop	cod. <b>07021302</b>
<b>012252.L79.X0.01</b>	gold F3" slim	cod. <b>07021304</b>
<b>012252.L79.X0.01</b>	gold F3" sottotop	cod. <b>07021306</b>
<b>012252.L79.X0.01</b>	gold F3" filotop	cod. <b>07021305</b>
<b>012252.L82.X0.01</b>	gun metal F3" slim	cod. <b>07021307</b>
<b>012252.L82.X0.01</b>	gun metal F3" sottotop	cod. <b>07021309</b>
<b>012252.L82.X0.01</b>	gun metal F3" filotop	cod. <b>07021308</b>

base incasso : mm 500  
 base sottotop : mm 600  
 base filotop : mm 500  
 profondità vasca : mm 190  
 foro incasso : mm 430 x 430  
 foro sottotop : mm 400 x 400 R10  
 foro filotop : manuale installazione  
 piletta standard manuale

## iride 57 x 45

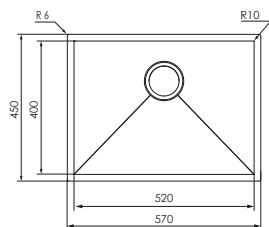

### Optionals

1.5	4.6	5.6	5.7	5.9	5.10	6.6	7.6	11.1
-----	-----	-----	-----	-----	------	-----	-----	------

<b>012258.L29.X0.01</b>	copper bronze F3" slim	cod. <b>07021321</b>
<b>012258.L29.X0.01</b>	copper bronze F3" sottotop	cod. <b>07021323</b>
<b>012258.L29.X0.01</b>	copper bronze F3" filotop	cod. <b>07021322</b>
<b>012258.L79.X0.01</b>	gold F3" slim	cod. <b>07021324</b>
<b>012258.L79.X0.01</b>	gold F3" sottotop	cod. <b>07021326</b>
<b>012258.L79.X0.01</b>	gold F3" filotop	cod. <b>07021325</b>
<b>012258.L82.X0.01</b>	gun metal F3" slim	cod. <b>07021327</b>
<b>012258.L82.X0.01</b>	gun metal F3" sottotop	cod. <b>07021329</b>
<b>012258.L82.X0.01</b>	gun metal F3" filotop	cod. <b>07021328</b>

base incasso : mm 600  
 base sottotop : mm 800  
 base filotop : mm 600  
 profondità vasca : mm 190  
 foro incasso : mm 550 x 430  
 foro sottotop : mm 520 x 400 R10  
 foro filotop : manuale installazione  
 piletta standard manuale

## iride 77 x 45

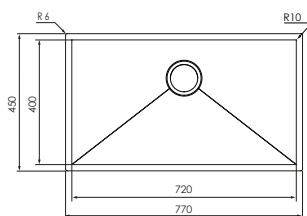

### Optionals

1.5	4.6	5.6	5.7	5.9	5.10	6.6	7.6	11.1
-----	-----	-----	-----	-----	------	-----	-----	------

<b>012256.L29.X0.01</b>	copper bronze F3" slim	cod. <b>07021341</b>
<b>012256.L29.X0.01</b>	copper bronze F3" sottotop	cod. <b>07021343</b>
<b>012256.L29.X0.01</b>	copper bronze F3" filotop	cod. <b>07021342</b>
<b>012256.L79.X0.01</b>	gold F3" slim	cod. <b>07021344</b>
<b>012256.L79.X0.01</b>	gold F3" sottotop	cod. <b>07021346</b>
<b>012256.L79.X0.01</b>	gold F3" filotop	cod. <b>07021345</b>
<b>012256.L82.X0.01</b>	gun metal F3" slim	cod. <b>07021347</b>
<b>012256.L82.X0.01</b>	gun metal F3" sottotop	cod. <b>07021349</b>
<b>012256.L82.X0.01</b>	gun metal F3" filotop	cod. <b>07021348</b>

base incasso : mm 800  
 base sottotop : mm 900  
 base filotop : mm 800  
 profondità vasca : mm 190  
 foro incasso : mm 750 x 430  
 foro sottotop : mm 720 x 400 R10  
 foro filotop : manuale installazione  
 piletta standard manuale





COLORSTYLE

# IRIDE MATT

## iride matt 45 x 45

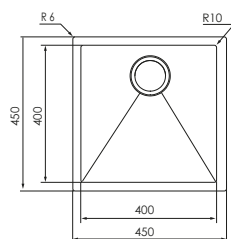

### Optionals

1.5	4.6	5.6	5.7	5.9	5.10	6.6	7.6	11.1
-----	-----	-----	-----	-----	------	-----	-----	------

<b>012352.L29.X0.01</b>	copper bronze F3" slim	cod. <b>07021311</b>
<b>012352.L29.X0.01</b>	copper bronze F3" sottotop	cod. <b>07021313</b>
<b>012352.L29.X0.01</b>	copper bronze F3" filotop	cod. <b>07021312</b>
<b>012352.L79.X0.01</b>	gold F3" slim	cod. <b>07021314</b>
<b>012352.L79.X0.01</b>	gold F3" sottotop	cod. <b>07021316</b>
<b>012352.L79.X0.01</b>	gold F3" filotop	cod. <b>07021315</b>
<b>012352.L82.X0.01</b>	gun metal F3" slim	cod. <b>07021317</b>
<b>012352.L82.X0.01</b>	gun metal F3" sottotop	cod. <b>07021319</b>
<b>012352.L82.X0.01</b>	gun metal F3" filotop	cod. <b>07021318</b>

base incasso : mm 500  
 base sottotop : mm 600  
 base filotop : mm 500  
 profondità vasca : mm 190  
 foro incasso : mm 430 x 430  
 foro sottotop : mm 400 x 400 R10  
 foro filotop : manuale installazione  
 piletta standard manuale

## iride matt 57 x 45

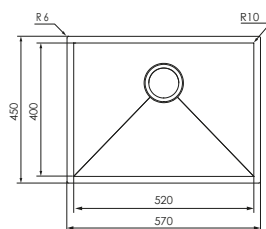

### Optionals

1.5	4.6	5.6	5.7	5.9	5.10	6.6	7.6	11.1
-----	-----	-----	-----	-----	------	-----	-----	------

<b>012358.L29.X0.01</b>	copper bronze F3" slim	cod. <b>07021331</b>
<b>012358.L29.X0.01</b>	copper bronze F3" sottotop	cod. <b>07021333</b>
<b>012358.L29.X0.01</b>	copper bronze F3" filotop	cod. <b>07021332</b>
<b>012358.L79.X0.01</b>	gold F3" slim	cod. <b>07021334</b>
<b>012358.L79.X0.01</b>	gold F3" sottotop	cod. <b>07021336</b>
<b>012358.L79.X0.01</b>	gold F3" filotop	cod. <b>07021335</b>
<b>012358.L82.X0.01</b>	gun metal F3" slim	cod. <b>07021337</b>
<b>012358.L82.X0.01</b>	gun metal F3" sottotop	cod. <b>07021339</b>
<b>012358.L82.X0.01</b>	gun metal F3" filotop	cod. <b>07021338</b>

base incasso : mm 600  
 base sottotop : mm 800  
 base filotop : mm 600  
 profondità vasca : mm 190  
 foro incasso : mm 550 x 430  
 foro sottotop : mm 520 x 400 R10  
 foro filotop : manuale installazione  
 piletta standard manuale

## iride matt 77 x 45

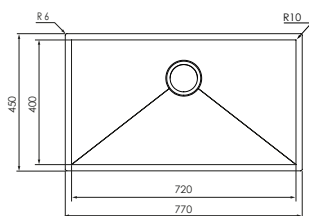

### Optionals

1.5	4.6	5.6	5.7	5.9	5.10	6.6	7.6	11.1
-----	-----	-----	-----	-----	------	-----	-----	------

<b>012356.L29.X0.01</b>	copper bronze F3" slim	cod. <b>07021351</b>
<b>012356.L29.X0.01</b>	copper bronze F3" sottotop	cod. <b>07021353</b>
<b>012356.L29.X0.01</b>	copper bronze F3" filotop	cod. <b>07021352</b>
<b>012356.L79.X0.01</b>	gold F3" slim	cod. <b>07023154</b>
<b>012356.L79.X0.01</b>	gold F3" sottotop	cod. <b>07023156</b>
<b>012356.L79.X0.01</b>	gold F3" filotop	cod. <b>07023155</b>
<b>012356.L82.X0.01</b>	gun metal F3" slim	cod. <b>07021357</b>
<b>012356.L82.X0.01</b>	gun metal F3" sottotop	cod. <b>07021359</b>
<b>012356.L82.X0.01</b>	gun metal F3" filotop	cod. <b>07021358</b>

base incasso : mm 800  
 base sottotop : mm 900  
 base filotop : mm 800  
 profondità vasca : mm 190  
 foro incasso : mm 750 x 430  
 foro sottotop : mm 720 x 400 R10  
 foro filotop : manuale installazione  
 piletta standard manuale

# Optionals **COLORSTYLE**

1.5



**092013**

**cod. 08711916A**  
mm 420 x 300  
economizzatore d'acqua  
in PPMAR

4.6



**093100**

**cod. 08711904**  
mm 330 x 390  
cestello inox

5.6



**094095**

**cod. 08711865A**  
mm 420 x 320  
tagliere PE bianco

5.7



**094096**

**cod. 08711865B**  
mm 250 x 415  
tagliere/copri vasca  
HPL nero

5.9



**094097**

**cod. 08711865C**  
mm 250 x 415  
griglia appoggio  
HPL nero

5.10



**094098**

**cod. 08711865D**  
mm 50 x 415  
n°2 barre multiuso  
HPL nero

6.6



**094073**

**cod. 08711808**  
mm 330 x 390  
tagliere iroko

7.6



**094071**

**cod. 08711815**  
mm 330 x 390  
tagliere iroko  
con inserto PE

11.1



**093004**

**cod. 08711929**  
mm 470x450  
tappetino inox  
arrotolabile



Optionals **COLORSTYLE**

Linea

# CLASSICSTYLE

Solidi e pratici con uno stile brillante come l'acciaio di cui sono fatti. L'esperienza di CM è tutta racchiusa qui: nella concreta sicurezza della sua linea Classicstyle.

Il cuore operativo della cucina è il lavello. CM lo sa bene perché da oltre 50 anni ne costruisce di ottimi: la gamma Classicstyle possiede tutti i requisiti essenziali per la perfetta efficienza quotidiana conservando sapore e calore dell'ambiente cucina. Top e lavelli belli e resistenti per definizione.

# CLASSIC



# CLASSIC

STYLE



# CLASSICSTYLE

## Profili

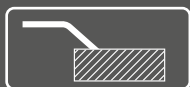

### STANDARD

Il volume c'è, ma quasi non si vede. Il bordo infatti sporge dal piano di lavoro, ma in modo elegantemente impercettibile: il merito va all'inedito sistema di piegatura utilizzato da CM.

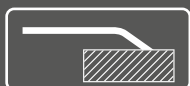

### PLUS

Igiene e look della cucina garantiti. La piegatura obliqua del bordo agevola le operazioni di pulizia, impedendo le incrostazioni di calcare e il deposito di fastidiosi residui.



### BORDO 8mm

Profilo deciso e linee marcate, un classico senza tempo: il lavello bello e robusto, come una volta. Essenziale, senza arretrare di un passo in fatto di raffinatezza e funzionalità.

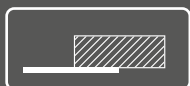

### SOTTOTOP

Sotto sotto c'è il lavello più innovativo, esclusivo e adatto alle soluzioni alternative. Per sfruttare al meglio gli spazi, forme rettangolari e circolari da fissare sotto il piano di lavoro.

# Finiture

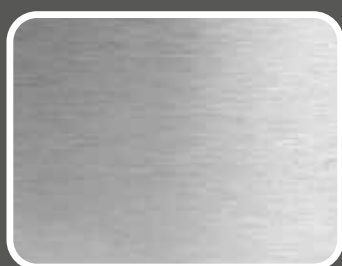

## SATINATO

Versatilità e praticità inossidabili: opaco ma lucente, l'acciaio satinato conserva per anni, inalterati, i suoi valori di eleganza, igiene e resistenza ai graffi ed all'usura dell'uso quotidiano.

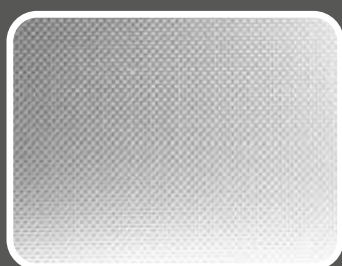

## ANTIGRAFFIO

L'eccellente acciaio inox con la superficie lavorata in una particolare texture che gli conferisce elevatissima resistenza alle abrasioni e dona alla lega metallica una tipica e gradevole lucentezza.

# Pilette e comandi



PILETTA STANDARD MANUALE



PILETTA STANDARD AUTOMATICA  
con COMANDO TONDO

# INDICE **CLASSIC**STYLE



80 ••• CRISTAL



82 ••• COMO



84 ••• ZENITH PLUS



86 ••• PUNTO PLUS



88 ••• ZENITH



90 ••• LEVANTE

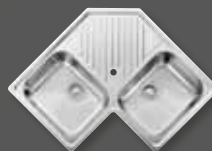

92 ••• ILARIA



93 ••• EUREKA



94 : MATICO



96 : COMETA



98 : AURORA



100 : UNIVERSAL



102 : NIHAL



104 : SIROS



106 : CINZIA

107 : Optionals

# CRISTAL

## cristal 79 x 50 1V

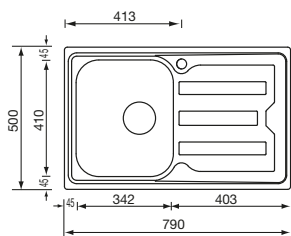

Optionals

1.1	3.1	4.4	6.3	6.13	7.4	11.1
-----	-----	-----	-----	------	-----	------

**010011.X2.01** satinato F3" standard cod. **07015301**

base: mm 450 / mm 500 se inizio composizione  
 profondità vasca : mm 210  
 foro incasso : mm 770 x 480  
 versione reversibile (X2) - piletta standard automatica con comando tondo

## cristal 79 x 50 2V

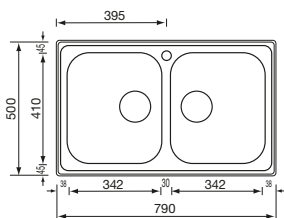

Optionals

1.1	1.2	3.1	4.4	6.3	6.13	7.4	11.1
-----	-----	-----	-----	-----	------	-----	------

**010012.X2.01** satinato F3" standard cod. **07015300**

base : mm 800 / mm 900 se inizio composizione  
 profondità vasche : mm 200  
 foro incasso : mm 770x 480  
 piletta standard manuale  
 versione reversibile (X2) - piletta standard automatica con comando tondo

## cristal 86 x 50 1V

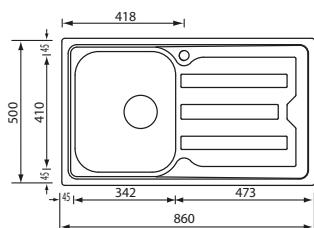

Optionals

1.1	3.1	4.4	6.3	6.13	7.4	11.1
-----	-----	-----	-----	------	-----	------

**010013.X2.01** satinato F3" standard cod. **07015311**

base : mm 450 / mm 500 se inizio composizione  
 profondità vasca: mm 210  
 foro incasso : mm 835 x 475  
 versione reversibile (X2) - piletta standard automatica con comando tondo

## cristal 86 x 50 2V

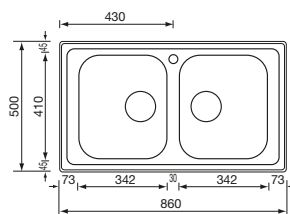

Optionals

1.1	1.2	3.1	4.4	6.3	6.13	7.4	11.1
-----	-----	-----	-----	-----	------	-----	------

**010014.X2.01** satinato F3" standard cod. **07015310**

base : mm 800 / mm 900 se inizio composizione  
 profondità vasche : mm 210  
 foro incasso: mm 835 x 475  
 piletta standard manuale  
 versione reversibile (X2) - piletta standard automatica con comando tondo

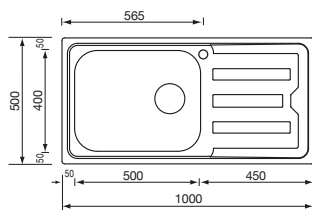

**cristal 100 x 50 1V****010016.X2.01** satinato F3" standard cod. **07015333**

base : mm 600/mm 800 se inizio composizione  
 profondità vasca : mm 210  
 foro incasso : mm 975 x 475  
 versione reversibile (X2) - piletta standard automatica con comando tondo

## Optionals

1.5	4.4	6.3	6.13	7.4	11.1
-----	-----	-----	------	-----	------

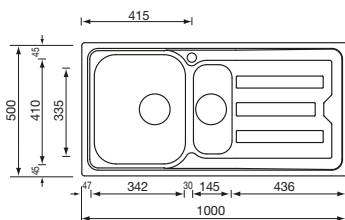
**cristal 100 x 50 2V****010015.X2.01** satinato F3" standard cod. **07015321**

base : mm 600 / mm 800 se inizio composizione  
 profondità vasche : mm 210 - 130  
 foro incasso : mm 975 x 475  
 versione reversibile (X2) - piletta standard automatica con comando tondo

## Optionals

1.1	1.2	2.1	3.1	4.3	4.4	6.3	6.13	7.4	11.1
-----	-----	-----	-----	-----	-----	-----	------	-----	------

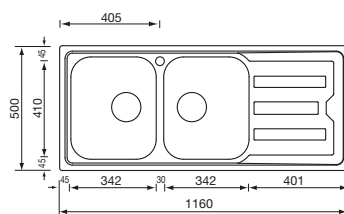
**cristal 116 x 50 2V****010017.X2.01** satinato F3" standard cod. **07015341**

base : mm 800 / mm 900 se inizio composizione  
 profondità vasche : mm 210  
 foro incasso : mm 1135 x 475  
 versione reversibile (X2) - piletta standard automatica con comando tondo

## Optionals

1.1	1.2	3.1	4.4	6.3	6.13	7.4	11.1
-----	-----	-----	-----	-----	------	-----	------

# COMO

## como 86 x 50 1V

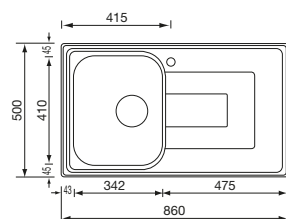

### Optionals

1.1	3.1	4.4	6.3	6.13	7.4	11.1
-----	-----	-----	-----	------	-----	------

**010143.X2.01** satinato F3" standard cod. **07011300**

base : mm 450 / mm 500 se inizio composizione  
 profondità vasca : mm 190  
 foro incasso : mm 835 x 475  
 versione reversibile (X2) - piletta standard automatica con comando tondo

## como 86 x 50 2V

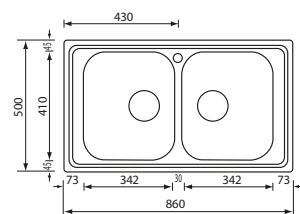

### Optionals

1.1	1.2	3.1	4.4	6.3	6.13	7.4	11.1
-----	-----	-----	-----	-----	------	-----	------

**010144.X2.01** satinato F3" standard cod. **07011302**

base : mm 800 / mm 900 se inizio composizione  
 profondità vasche : mm 190  
 foro incasso : mm 835 x 475  
 piletta standard manuale  
 versione reversibile (X2) - piletta standard automatica con comando tondo

## como 100 x 50 1V

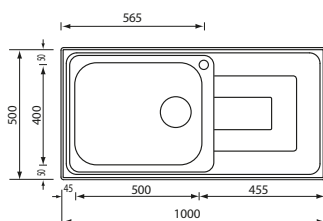

### Optionals

1.5	4.4	6.3	6.13	7.4	11.1
-----	-----	-----	------	-----	------

**010146.X2.01** satinato F3" standard cod. **07011303**

base : mm 600 / mm 800 se inizio composizione  
 profondità vasca : mm 210  
 foro incasso : mm 975 x 475  
 versione reversibile (X2) - piletta standard automatica con comando tondo

## como 100 x 50 2V

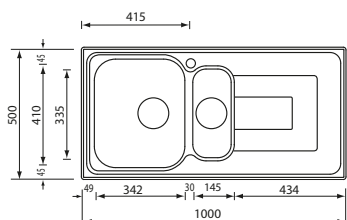

### Optionals

1.1	1.2	2.1	3.1	4.3	4.4	6.3	6.13	7.4	11.1
-----	-----	-----	-----	-----	-----	-----	------	-----	------

**010145.X2.01** satinato F3" standard cod. **07011304**

base : mm 600 / mm 800 se inizio composizione  
 profondità vasche : mm 190 - 130  
 foro incasso : mm 975 x 475  
 versione reversibile (X2) - piletta standard automatica con comando tondo

como 116 x 50 2V

010147.X2.01 satinato F3" standard cod. 07011306

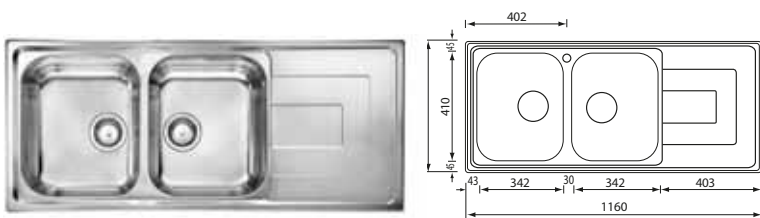

base : mm 800 / mm 900 se inizio composizione

profondità vasche : mm 190

foro incasso : mm 1135 x 475

versione reversibile (X2) - piletta standard automatica con comando tondo

Optionals

1.1	1.2	3.1	4.4	6.3	6.13	7.4	11.1
-----	-----	-----	-----	-----	------	-----	------



# ZENITH PLUS

## zenith plus 79 x 50 1V

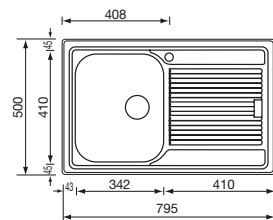

Optionals

1.1	3.1	4.4	6.3	6.13	7.4	11.1
-----	-----	-----	-----	------	-----	------

**011251.D1.01** satinato F3" plus dx cod. **07020821**

**011251.S1.01** satinato F3" plus sx cod. **07020822**

base : mm 450 / mm 500 se inizio composizione  
 profondità vasca : mm 210  
 foro incasso : mm 775 x 480  
 versione DX e SX - piletta standard manuale

## zenith plus 79 x 50 2V

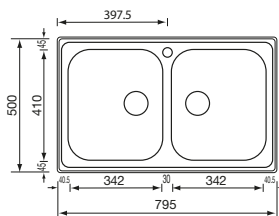

Optionals

1.1	1.2	3.1	4.4	6.3	6.13	7.4	11.1
-----	-----	-----	-----	-----	------	-----	------

**011252.X1.01** satinato F3" plus cod. **07020820**

base : mm 800 / mm 900 se inizio composizione  
 profondità vasche : mm 210  
 foro incasso : mm 775 x 480  
 piletta standard manuale

## zenith plus 86 x 50 1V

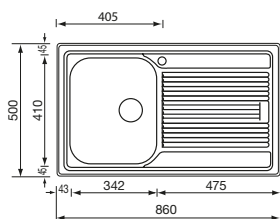

Optionals

1.1	3.1	4.4	6.3	6.13	7.4	11.1
-----	-----	-----	-----	------	-----	------

**011253.D1.01** satinato F3" plus dx cod. **07020921**

**011253.S1.01** satinato F3" plus sx cod. **07020922**

base : mm 450 / mm 500 se inizio composizione  
 profondità vasca : mm 210  
 foro incasso : mm 840 x 480  
 versione DX e SX - piletta standard manuale

## zenith plus 86 x 50 2V

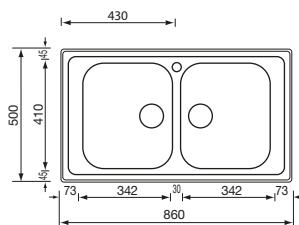

Optionals

1.1	1.2	3.1	4.4	6.3	6.13	7.4	11.1
-----	-----	-----	-----	-----	------	-----	------

**011254.X1.01** satinato F3" plus cod. **07020920**

base : mm 800 / mm 900 se inizio composizione  
 profondità vasche : mm 210  
 foro incasso : mm 840 x 480  
 piletta standard manuale

### zenith plus 100 x 50 2V

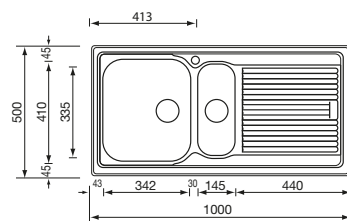

**011255.D1.01** satinato F3" plus dx cod. **07021021**

**011255.S1.01** satinato F3" plus sx cod. **07021022**

base : mm 600 / mm 800 se inizio composizione

profondità vasche: mm 210 - 130

foro incasso : mm 980 x 480

versione DX e SX - piletta standard manuale

#### Optionals

1.1 | 1.2 | 2.1 | 3.1 | 4.3 | 4.4 | 6.3 | 6.13 | 7.4 | 11.1

### zenith plus 116 x 50 2V

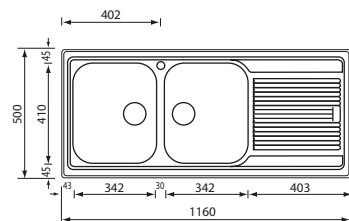

**011257.D1.01** satinato F3" plus dx cod. **07021221**

**011257.S1.01** satinato F3" plus sx cod. **07021222**

base : mm 800 / mm 900 se inizio composizione

profondità vasche : mm 210

foro incasso : mm 1140 x 480

versione DX e SX - piletta standard manuale

#### Optionals

1.1 | 1.2 | 3.1 | 4.4 | 6.3 | 6.13 | 7.4 | 11.1





# PUNTO PLUS

## punto plus 86 x 50 1V

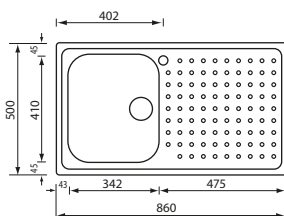

**011103.D1.01** satinato F3"plus dx cod. **07020931**

**011103.S1.01** satinato F3"plus sx cod. **07020932**

base : mm 450 / mm 500 se inizio composizione

profondità vasca : mm 200

foro incasso : mm 840 x 480

versione DX e SX - piletta standard manuale

### Optionals

1.1	3.1	4.4	6.3	6.13	7.4	11.1
-----	-----	-----	-----	------	-----	------

## punto plus 86 x 50 1V mm 400x400

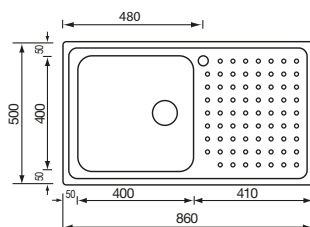

**011113.D1.01** satinato F3"plus dx cod. **07020941**

**011113.S1.01** satinato F3"plus sx cod. **07020942**

base : mm 600

profondità vasca : mm 210

foro incasso : mm 840 x 480

versione DX e SX - piletta standard manuale

### Optionals

1.5	4.4	6.3	6.13	7.4	11.1
-----	-----	-----	------	-----	------

## punto plus 86 x 50 2V

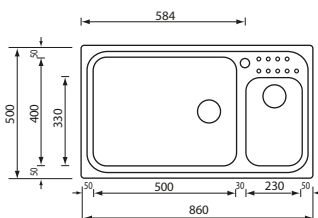

**011114.D1.01** satinato F3"plus dx cod. **07020911**

**011114.S1.01** satinato F3"plus sx cod. **07020912**

base : mm 900

profondità vasche: mm 210 - 160

foro incasso : mm 840 x 480

versione DX e SX - piletta standard manuale

### Optionals

1.2	1.5	4.4	6.3	6.13	7.4	11.1
-----	-----	-----	-----	------	-----	------

## punto plus 116 x 50 2V

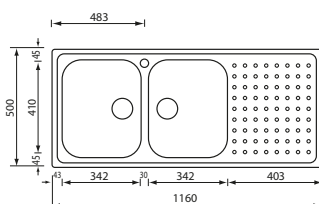

**011107.D1.01** satinato F3"plus dx cod. **07021241**

**011107.S1.01** satinato F3"plus sx cod. **07021242**

base : mm 800 / mm 900 se inizio composizione

profondità vasche : mm 200

foro incasso : mm 1140 x 480

versione DX e SX - piletta standard manuale

### Optionals

1.1	1.2	3.1	4.4	6.3	6.13	7.4	11.1
-----	-----	-----	-----	-----	------	-----	------



# ZENITH

## zenith 79 x 50 1V

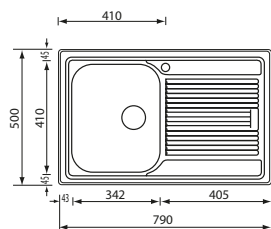

**011241.D1.01** satinato F3" standard dx cod. **07020831**

**011241.S1.01** satinato F3" standard sx cod. **07020832**

base : mm 450 / mm 500 se inizio composizione  
 profondità vasca : mm 190  
 foro incasso : mm 770 x 480  
 versione DX e SX - piletta standard manuale

### Optionals

1.1	3.1	4.4	6.3	6.13	7.4	11.1
-----	-----	-----	-----	------	-----	------

## zenith 79 x 50 2V

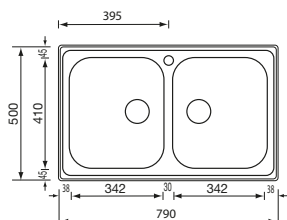

**011242.X1.01** satinato F3" standard cod. **07020830**

base : mm 800 / mm 900 se inizio composizione  
 profondità vasche : mm 180  
 foro incasso : mm 770 x 480  
 piletta standard manuale

### Optionals

1.1	1.2	3.1	4.4	6.3	6.13	7.4	11.1
-----	-----	-----	-----	-----	------	-----	------

## zenith 86 x 50 1V

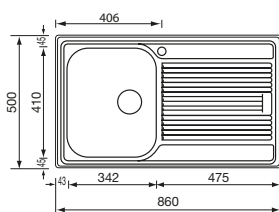

**011243.D1.01** satinato F3" standard dx cod. **07020841**

**011243.S1.01** satinato F3" standard sx cod. **07020842**

base : mm 450 / mm 500 se inizio composizione  
 profondità vasca : mm 190  
 foro incasso : mm 835 x 475  
 versione DX e SX - piletta standard manuale

### Optionals

1.1	3.1	4.4	6.3	6.13	7.4	11.1
-----	-----	-----	-----	------	-----	------

## zenith 86 x 50 2V

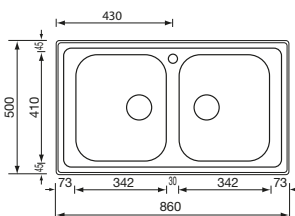

**011244.X1.01** satinato F3" standard cod. **07020840**

base : mm 800 / mm 900 se inizio composizione  
 profondità vasche : mm 190  
 foro incasso : mm 835 x 475  
 piletta standard manuale

### Optionals

1.1	1.2	3.1	4.4	6.3	6.13	7.4	11.1
-----	-----	-----	-----	-----	------	-----	------

## zenith 100 x 50 2V

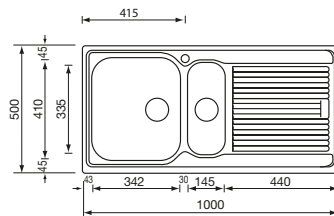

**011245.D1.01** satinato F3" standard dx cod. **07020851**

**011245.S1.01** satinato F3" standard sx cod. **07020852**

base : mm 600 / mm 800 se inizio composizione

profondità vasche : mm 190 - 130

foro incasso : mm 975 x 475

versione DX e SX - piletta standard manuale

### Optionals

1.1	1.2	2.1	3.1	4.3	4.4	6.3	6.13	7.4	11.1
-----	-----	-----	-----	-----	-----	-----	------	-----	------

## zenith 116 x 50 2V

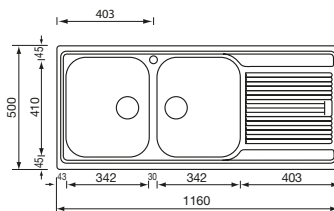

**011247.D1.01** satinato F3" standard dx cod. **07020861**

**011247.S1.01** satinato F3" standard sx cod. **07020862**

base : mm 800 / mm 900 se inizio composizione

profondità vasche : mm 190

foro incasso : mm 1135 x 475

versione DX e SX - piletta standard manuale

### Optionals

1.1	1.2	3.1	4.4	6.3	6.13	7.4	11.1
-----	-----	-----	-----	-----	------	-----	------

## zenith 83 x 83 2V

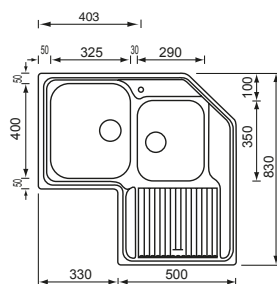

**011248.D1.01** satinato F3" bordo h 8 dx cod. **07021061**

**011248.S1.01** satinato F3" bordo h 8 sx cod. **07021062**

base : mm 900

profondità vasche : mm 190 - 180

foro incasso : vedi schema - *see diagram*

versione DX e SX - piletta standard manuale

**senza guarnizione premontata**

### Optionals

1.2	3.15	4.4	6.3	6.13	7.4	11.1
-----	------	-----	-----	------	-----	------

# LEVANTE

## levante 79 x 50 1V

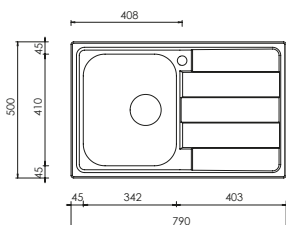

### Optionals

1.1	3.1	4.4	6.3	6.13	7.4	11.1
-----	-----	-----	-----	------	-----	------

**015721.D1.01** satinato F3" standard dx cod. **07020001**

**015721.S1.01** satinato F3" standard sx cod. **07020002**

base : mm 450 / mm 500 se inizio composizione

profondità vasca : mm 210

foro incasso : mm 770 x 480

versione DX e SX - piletta standard manuale

## levante 79 x 50 2V

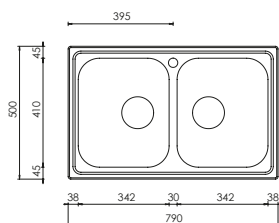

### Optionals

1.1	1.2	3.1	4.4	6.3	6.13	7.4	11.1
-----	-----	-----	-----	-----	------	-----	------

**015722.X1.01** satinato F3" standard cod. **07020000**

base : mm 800 / mm 900 se inizio composizione

profondità vasche : mm 200

foro incasso : mm 770 x 480

piletta standard manuale

## levante 86 x 50 1V

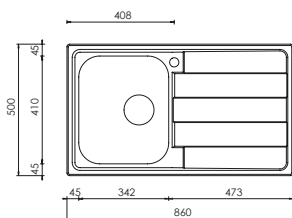

### Optionals

1.1	3.1	4.4	6.3	6.13	7.4	11.1
-----	-----	-----	-----	------	-----	------

**015723.D1.01** satinato F3" standard dx cod. **07020011**

**015723.S1.01** satinato F3" standard sx cod. **07020012**

base : mm 450 / mm 500 se inizio composizione

profondità vasca : mm 210

foro incasso : mm 835 x 475

versione DX e SX - piletta standard manuale

## levante 86 x 50 2V

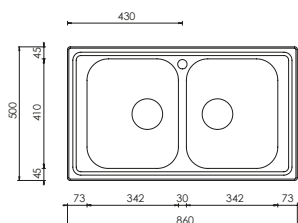

### Optionals

1.1	1.2	3.1	4.4	6.3	6.13	7.4	11.1
-----	-----	-----	-----	-----	------	-----	------

**015724.X1.01** satinato F3" standard cod. **07020010**

base : mm 800 / mm 900 se inizio composizione

profondità vasche : mm 210

foro incasso : mm 835 x 475

piletta standard manuale



### levante 100 x 50 1V

**015726.D1.01** satinato F3" standard dx cod. **07020021**

**015726.S1.01** satinato F3" standard sx cod. **07020022**

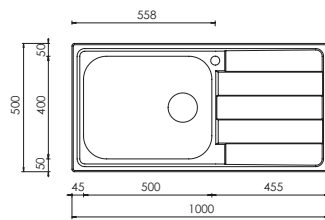

base : mm 600 / mm 800 se inizio composizione  
profondità vasca : mm 210  
foro incasso: mm 975 x 475  
versione DX e SX - piletta standard manuale

#### Optionals

1.5 | 4.4 | 6.3 | 6.13 | 7.4 | 11.1

### levante 100 x 50 2V

**015725.D1.01** satinato F3" standard dx cod. **07020031**

**015725.S1.01** satinato F3" standard sx cod. **07020032**

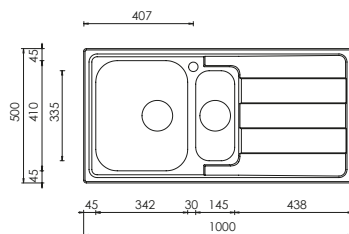

base : mm 600 / mm 800 se inizio composizione  
profondità vasche : mm 210 - 130  
foro incasso : mm 975 x 475  
versione DX e SX - piletta standard manuale

#### Optionals

1.1 | 1.2 | 2.1 | 3.1 | 4.3 | 4.4 | 6.3 | 6.13 | 7.4 | 11.1

### levante 116 x 50 2V

**015727.D1.01** satinato F3" standard dx cod. **07020041**

**015727.S1.01** satinato F3" standard sx cod. **07020042**

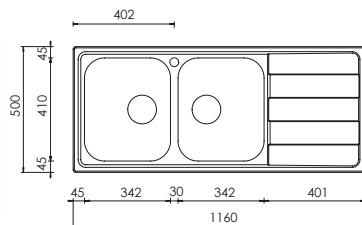

base : mm 800 / mm 900 se inizio composizione  
profondità vasche : mm 210  
foro incasso : mm 1135 x 475  
versione DX e SX - piletta standard manuale

#### Optionals

1.1 | 1.2 | 3.1 | 4.4 | 6.3 | 6.13 | 7.4 | 11.1

# ILARIA

**ilaria 83 x 83 2V**

**011840.X1.01** satinato F3" bordo h 8 cod. **07021050**

**011890.X1.01** antigraffio F3" bordo h 8 cod. **07041050**

base: mm 900 x 900  
profondità vasche : mm 190  
foro incasso : manuale installazione  
piletta standard manuale

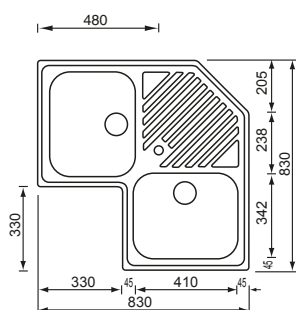

Optionals

1.1	3.1	4.4	6.3	6.13	7.4	11.1
-----	-----	-----	-----	------	-----	------



# EUREKA

## eureka 86 x 51 1V

**011753.D1.01** satinato F3" bordo h 8 dx cod. **07020951**

**011753.S1.01** satinato F3" bordo h 8 sx cod. **07020952**

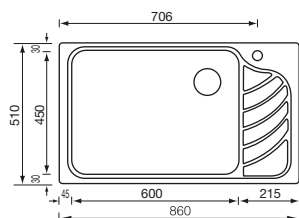

base : mm 800  
 profondità vasca : mm 220  
 foro incasso : mm 840 x 490  
 versione DX e SX - piletta standard manuale

### Optionals

1.3	4.4	6.5	7.5	8.4
-----	-----	-----	-----	-----

## eureka 86 x 51 1V monostampo

**011743.X1.01** satinato F3" bordo h 8 cod. **07020950**

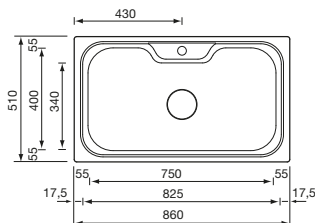

base : mm 800 / mm 900 se inizio composizione  
 profondità vasca : mm 220  
 foro incasso : mm 840 x 490  
 piletta standard manuale

### Optionals

1.4	4.13	6.5	7.5	7.7	8.3	8.4	11.1
-----	------	-----	-----	-----	-----	-----	------



# MATICO

## matico 58 x 50 2V

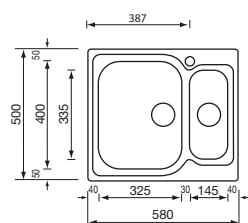

**011642.D1.01** satinato F3" plus dx cod. **07020751**

**011642.S1.01** satinato F3" plus sx cod.

base : mm 600  
 profondità vasche : mm 190 - 130  
 foro incasso : mm 560 x 480  
 versione DX e SX - piletta standard manuale  
**senza guarnizione premontata**

### Optionals

1.2	2.1	3.15	4.3	4.4	6.3	6.13	7.4	11.1
-----	-----	------	-----	-----	-----	------	-----	------

## matico 58 x 50 1V

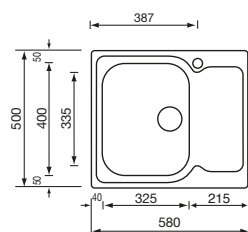

**011640.D1.01** satinato F3" plus dx cod. **07020753**

**011640.S1.01** satinato F3" plus sx cod. **07020754**

base : mm 600  
 profondità vasca : mm 190  
 foro incasso : mm 560 x 480  
 versione DX e SX - piletta standard manuale  
**senza guarnizione premontata**

### Optionals

3.15	4.4	6.3	6.13	7.4	11.1
------	-----	-----	------	-----	------

## matico 79 x 50 2V

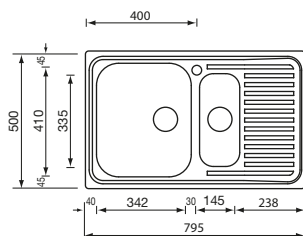

**011641.D1.01** satinato F3" plus dx cod. **07020761**

**011641.S1.01** satinato F3" plus sx cod. **07020762**

base : mm 600 / mm 800 se inizio composizione  
 profondità vasche : mm 190 - 130  
 foro incasso : mm 775 x 480  
 versione DX e SX - piletta standard manuale  
**senza guarnizione premontata**

### Optionals

1.1	1.2	2.1	3.1	4.3	4.4	6.3	6.13	7.4	11.1
-----	-----	-----	-----	-----	-----	-----	------	-----	------

## matico 86 x 50 1V

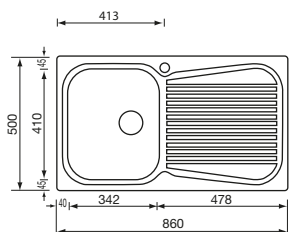

**011643.D1.01** satinato F3" standard dx cod. **07020741**

**011643.S1.01** satinato F3" standard sx cod. **07020742**

base : mm 450 / mm 500 se inizio composizione  
 profondità vasca : mm 190  
 foro incasso : mm 835 x 475  
 versione DX e SX - piletta standard manuale

### Optionals

1.1	3.1	4.4	6.3	7.4	11.1
-----	-----	-----	-----	-----	------

### matico 100 x 50 2V

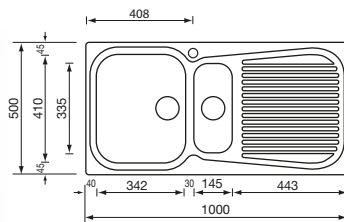

**011645.D1.01** satinato F3" plus dx cod. **07021001**

**011645.S1.01** satinato F3" plus sx cod. **07021002**

base: mm 600 / mm 800 se inizio composizione  
profondità vasche: mm 190 - 130  
foro incasso : mm 980 x 480  
versione DX e SX - piletta standard manuale  
**senza guarnizione premontata**

#### Optionals

1.1	1.2	2.1	3.1	4.3	4.4	6.3	7.4	11.1
-----	-----	-----	-----	-----	-----	-----	-----	------

### matico 100 x 50 3V

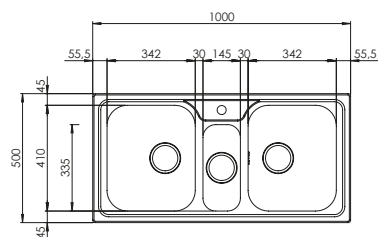

**011646.X1.01** satinato F3" standard cod. **07021000**

base: mm 1000  
profondità vasche : mm 190 - 130  
foro incasso : mm 975 x 475  
piletta standard manuale

#### Optionals

1.1	1.2	2.1	3.1	4.3	4.4	6.3	6.13	7.4	11.1
-----	-----	-----	-----	-----	-----	-----	------	-----	------

### matico 116 x 50 2V

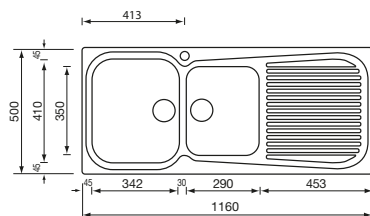

**011647.D1.01** satinato F3" standard dx cod. **07021251**

**011647.S1.01** satinato F3" standard sx cod. **07021252**

base : mm 800  
profondità vasche : mm 190 - 180  
foro incasso : mm 1135 x 475  
versione DX e SX - piletta standard manuale

#### Optionals

1.1	1.2	3.1	4.4	6.3	7.4	11.1
-----	-----	-----	-----	-----	-----	------



# COMETA

## cometa 79 x 50 1V

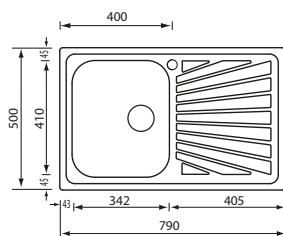

- 011441.D1.01** satinato F3" standard dx cod. **07020801**
- 011441.S1.01** satinato F3" standard sx cod. **07020802**
- 011491.D1.01** antigraffio F3" standard dx cod. **07040801**
- 011491.S1.01** antigraffio F3" standard sx cod. **07040802**

base: mm 450 / mm 500 se inizio composizione  
 profondità vasca : mm 190  
 foro incasso : mm 770 x 480  
 versione DX e SX - piletta standard manuale

### Optionals

1.1	3.1	4.4	6.3	6.13	7.4	11.1
-----	-----	-----	-----	------	-----	------

## cometa 79 x 50 2V

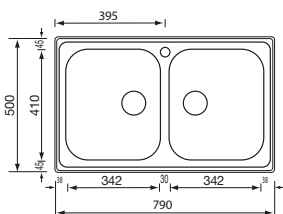

- 011442.X1.01** satinato F3" standard cod. **07020800**
- 011492.X1.01** antigraffio F3" standard cod. **07040800**

base : mm 800 / mm 900 se inizio composizione  
 profondità vasche: mm 180  
 foro incasso : mm 770 x 480  
 piletta standard manuale

### Optionals

1.1	1.2	3.1	4.4	6.3	6.13	7.4	11.1
-----	-----	-----	-----	-----	------	-----	------

## cometa 86 x 50 1V

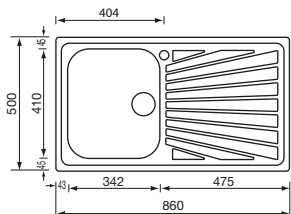

- 011443.D1.01** satinato F3" standard dx cod. **07020901**
- 011443.S1.01** satinato F3" standard sx cod. **07020902**
- 011493.D1.01** antigraffio F3" standard dx cod. **07040901**
- 011493.S1.01** antigraffio F3" standard sx cod. **07040902**

base : mm 450 / mm 500 se inizio composizione  
 profondità vasca : mm 190  
 foro incasso : mm 835 x 475  
 versione DX e SX - piletta standard manuale

### Optionals

1.1	3.1	4.4	6.3	6.13	7.4	11.1
-----	-----	-----	-----	------	-----	------

## cometa 86 x 50 2V

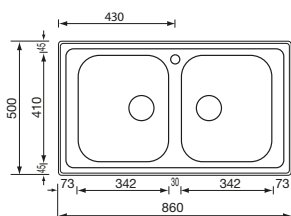

- 011444X1.01** satinato F3" standard cod. **07020900**
- 011494.X1.01** antigraffio F3" standard cod. **07040900**

base : mm 800 / mm 900 se inizio composizione  
 profondità vasche : mm 190  
 foro incasso : mm 835 x 475  
 piletta standard manuale

### Optionals

1.1	1.2	3.1	4.4	6.3	6.13	7.4	11.1
-----	-----	-----	-----	-----	------	-----	------

### cometa 100 x 50 1V

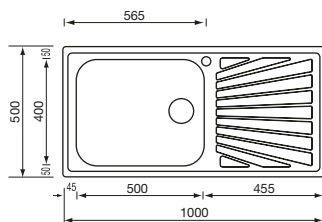

**011446.D1.01** satinato F3" standard dx cod. **07021071**

**011446.S1.01** satinato F3" standard sx cod. **07021072**

base: mm 600 / mm 800 se inizio composizione  
profondità vasca : mm 210  
foro incasso: mm 975 x 475  
versione DX e SX - piletta standard manuale

#### Optionals

1.5	4.4	6.3	6.13	7.4	11.1
-----	-----	-----	------	-----	------

### cometa 100 x 50 2V

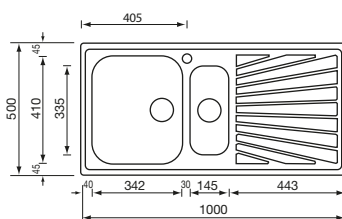

**011445.D1.01** satinato F3" standard dx cod. **07021041**

**011445.S1.01** satinato F3" standard sx cod. **07021042**

**011495.D1.01** antigraffio F3" standard dx cod. **07041041**

**011495.S1.01** antigraffio F3" standard sx cod. **07041042**

base : mm 600 / mm 800 se inizio composizione  
profondità vasche : mm 190 - 130  
foro incasso : mm 975 x 475  
versione DX e SX - piletta standard manuale

#### Optionals

1.1	1.2	2.1	3.1	4.3	4.4	6.3	6.13	7.4	11.1
-----	-----	-----	-----	-----	-----	-----	------	-----	------

### cometa 116 x 50 2V

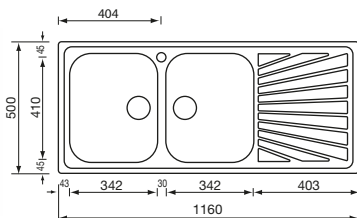

**011447.D1.01** satinato F3" standard dx cod. **07021211**

**011447.S1.01** satinato F3" standard sx cod. **07021212**

**011497.D1.01** antigraffio F3" standard dx cod. **07041201**

**011497.S1.01** antigraffio F3" standard sx cod. **07041202**

base : mm 800 / mm 900 se inizio composizione  
profondità vasche : mm 190  
foro incasso : mm 1135 x 475  
versione DX e SX - piletta standard manuale

#### Optionals

1.1	1.2	3.1	4.4	6.3	6.13	7.4	11.1
-----	-----	-----	-----	-----	------	-----	------

# AURORA

## aurora 101 x 50 1V

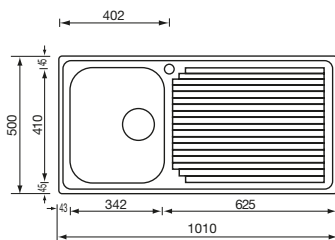

**011045.D1.01** satinato F3" plus dx cod. **07021011**

**011045.S1.01** satinato F3" plus sx cod. **07021012**

base : mm 450 / mm 500 se inizio composizione  
 profondità vasca : mm 180  
 foro incasso : mm 990 x 480  
 versione DX e SX - piletta standard manuale

### Optionals

1.1 | 3.1 | 4.4 | 6.3 | 7.4 | 11.1

## aurora 116 x 50 1V

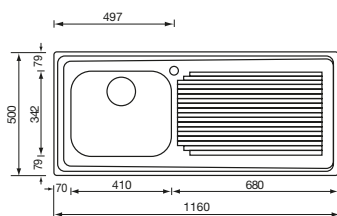

**011046.D1.01** satinato F3" plus dx cod. **07021201**

**011046.S1.01** satinato F3" plus sx cod. **07021202**

base : mm 600  
 profondità vasca : mm 190  
 foro incasso : mm 1140 x 480  
 versione DX e SX - piletta standard manuale

### Optionals

1.1 | 3.1 | 4.4 | 6.3 | 7.4 | 11.1

## aurora 79 x 42 1V

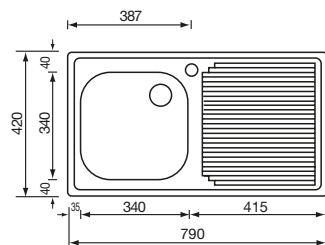

**011011.D1.01** satinato F2" bordo h 8 dx cod. **07020501**

**011011.S1.01** satinato F2" bordo h 8 sx cod. **07020502**

base : mm 450  
 profondità vasca : mm 170  
 foro incasso : mm 770 x 400  
 versione DX e SX - piletta standard manuale

### Optionals

6.9 | 11.1

## aurora 79 x 42 2V

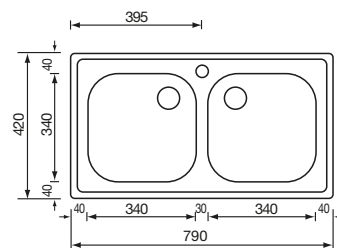

**011012.X1.01** satinato F2" bordo h 8 cod. **07020500**

base : mm 800 / mm 900 se inizio composizione  
 profondità vasche : mm 170  
 foro incasso : mm 770 x 400  
 piletta standard manuale

### Optionals

6.9 | 11.1

**aurora 116 x 42 2V**

**011017.D1.01** satinato F2" bordo h 8 dx cod. **07020601**

**011017.S1.01** satinato F2" bordo h 8 sx cod. **07020602**

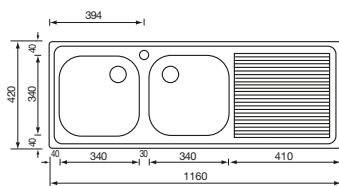

base : mm 800 / mm 900 se inizio composizione  
profondità vasche: mm 170  
foro incasso: mm 1140 x 400  
versione DX e SX - piletta standard manuale

Optionals

6.9 | 11.1



# UNIVERSAL

## universal 86 x 50 1V

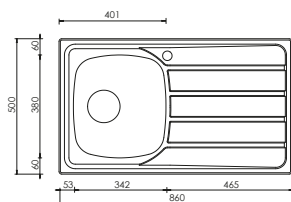
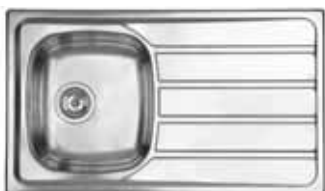

Optionals

4.10 | 6.3 | 6.13 | 7.4 | 11.1

**015443.D1.01** satinato F3" standard dx cod. **07020111**

**015443.S1.01** satinato F3" standard sx cod. **07020112**

base: mm 450  
 profondità vasca : mm 160  
 foro incasso : mm 835 x 475  
 versione DX e SX - piletta standard manuale

## universal 86 x 50 2V

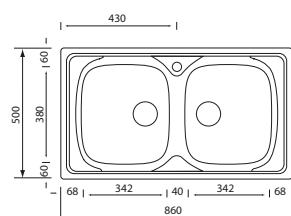

Optionals

4.10 | 6.3 | 6.13 | 7.4 | 11.1

**015444.X1.01** satinato F3" standard cod. **07020110**

base : mm 800 / mm 900 se inizio composizione  
 profondità vasche : mm 160  
 foro incasso : mm 835 x 475  
 piletta standard manuale

## universal 86 x 50 1V mm 450 x 400

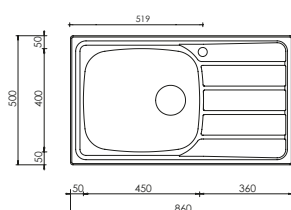

Optionals

4.10 | 6.3 | 7.4 | 11.1

**015440.D1.01** satinato F3" standard dx cod. **07020116**

**015440.S1.01** satinato F3" standard sx cod. **07020117**

base: mm 600  
 profondità vasca : mm 160  
 foro incasso : mm 835 x 475  
 versione DX e SX - piletta standard manuale

## universal 100 x 50 1V mm 450 x 400

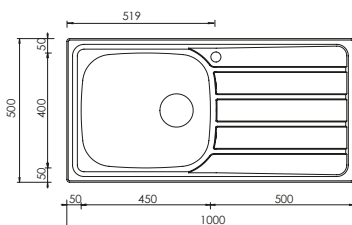

Optionals

4.10 | 6.3 | 7.4 | 11.1

**015446.D1.01** satinato F3" standard dx cod. **07020121**

**015446.S1.01** satinato F3" standard sx cod. **07020122**

base : mm 600  
 profondità vasca : mm 160  
 foro incasso : mm 975 x 475  
 versione DX e SX - piletta standard manuale



## universal 100 x 50 2V

**015445.D1.01** satinato F3"standard dx cod. **07020125**

**015445.S1.01** satinato F3"standard sx cod. **07020126**

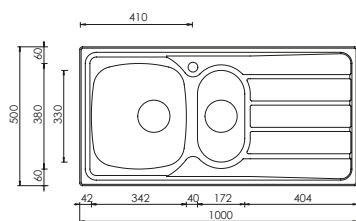

base: mm 600 / mm 800 se inizio composizione  
profondità vasche : mm 160 - 100  
foro incasso : mm 975 x 475  
versione DX e SX - piletta standard manuale

Optionals

4.10 | 6.3 | 6.13 | 7.4 | 11.1

## universal 116 x 50 2V

**015447.D1.01** satinato F3"standard dx cod. **07020141**

**015447.S1.01** satinato F3"standard sx cod. **07020142**

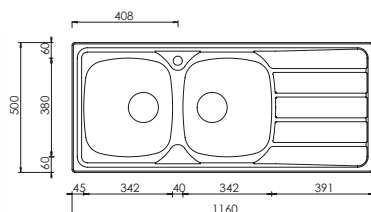
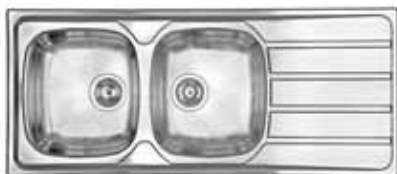

base : mm 800 / mm 900 se inizio composizione  
profondità vasche : mm 160  
foro incasso : mm 1135 x 475  
versione DX e SX - piletta standard manuale

Optionals

4.10 | 6.3 | 6.13 | 7.4 | 11.1



# NIHAL

## nihal 79 x 50 1V

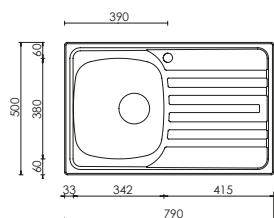

**010841.D1.01** satinato F3" standard dx cod. **07020351**

**010841.S1.01** satinato F3" standard sx cod. **07020352**

base : mm 450  
 profondità vasca : mm 150  
 foro incasso : mm 770 x 480  
 versione DX e SX - piletta standard manuale

Optionals

4.10	6.3	6.13	7.4	11.1
------	-----	------	-----	------

## nihal 79 x 50 2V

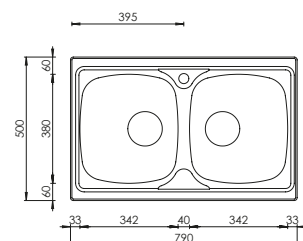

**010842.X1.01** satinato F3" standard cod. **07020350**

base : mm 800 / mm 900 se inizio composizione  
 profondità vasche : mm 150  
 foro incasso : mm 770 x 480  
 piletta standard manuale

Optionals

4.10	6.3	6.13	7.4	11.1
------	-----	------	-----	------

## nihal 86 x 50 1V

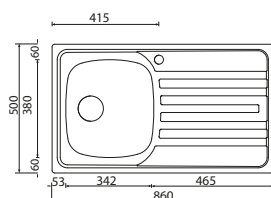

**010843.D1.01** satinato F3" standard dx cod. **07020361**

**010843.S1.01** satinato F3" standard sx cod. **07020362**

base : mm 450  
 profondità vasca : mm 150  
 foro incasso : mm 835 x 475  
 versione DX e SX - piletta standard manuale

Optionals

4.10	6.3	6.13	7.4	11.1
------	-----	------	-----	------

## nihal 86 x 50 2V

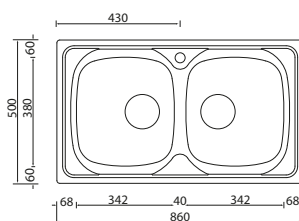

**010844.X1.01** satinato F3" standard cod. **07020360**

base : mm 800 / mm 900 se inizio composizione  
 profondità vasche : mm 160  
 foro incasso : mm 835 x 475  
 piletta standard manuale

Optionals

4.10	6.3	6.13	7.4	11.1
------	-----	------	-----	------

## nihal 100 x 50 2V

**010845.D1.01** satinato F3" standard dx cod. **07020371**

**010845.S1.01** satinato F3" standard sx cod. **07020372**

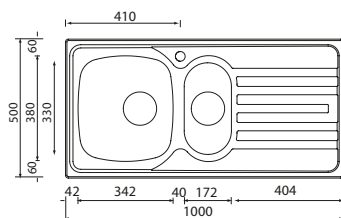

base: mm 600/mm 800 se inizio composizione  
profondità vasche: mm 160 - 100  
foro incasso: mm 975 x 475  
versione DX e SX - piletta standard manuale

### Optionals

4.10 | 6.3 | 6.13 | 7.4 | 11.1

## nihal 116 x 50 2V

**010847.D1.01** satinato F3" standard dx cod. **07020381**

**010847.S1.01** satinato F3" standard sx cod. **07020382**

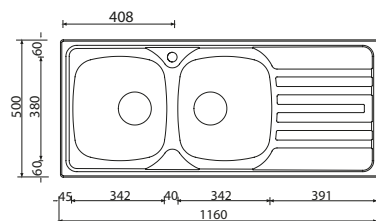

base: mm 800/mm 900 se inizio composizione  
profondità vasche: mm 150  
foro incasso: mm 1135 x 475  
versione DX e SX - piletta standard manuale

### Optionals

4.10 | 6.3 | 6.13 | 7.4 | 11.1



# SIROS

## siros 79 x 50 1V

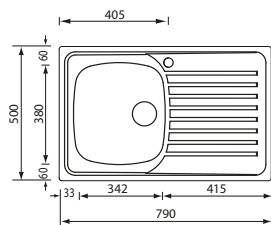

Optionals

4.10	6.3	6.13	7.4	11.1
------	-----	------	-----	------

**010451.D1.01** prelucidato F3" standard dx cod. **07080801**

**010451.S1.01** prelucidato F3" standard sx cod. **07080802**

base : mm 450

profondità vasca : mm 160

foro incasso : mm 770 x 480

versione DX e SX - piletta standard manuale

## siros 79 x 50 2V

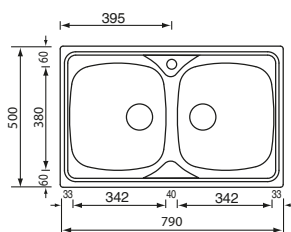

Optionals

4.10	6.3	6.13	7.4	11.1
------	-----	------	-----	------

**010452.X1.01** prelucidato F3" standard cod. **07080800**

base : mm 800 / mm 900 se inizio composizione

profondità vasche : mm 160

foro incasso : mm 770 x 480

piletta standard manuale

## siros 86 x 50 1V

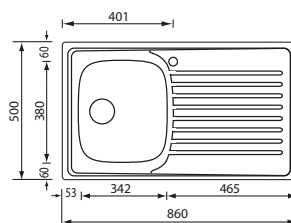

Optionals

4.10	6.3	6.13	7.4	11.1
------	-----	------	-----	------

**010453.D1.01** prelucidato F3" standard dx cod. **07080901**

**010453.S1.01** prelucidato F3" standard sx cod. **07080902**

base : mm 450

profondità vasca : mm 160

foro incasso : mm 835 x 475

versione DX e SX - piletta standard manuale

## siros 86 x 50 2V

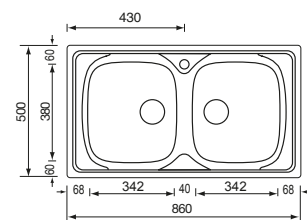

Optionals

4.10	6.3	6.13	7.4	11.1
------	-----	------	-----	------

**010454.X1.01** prelucidato F3" standard cod. **07080900**

base : mm 800 / mm 900 se inizio composizione

profondità vasche : mm 160

foro incasso : mm 835 x 475

piletta standard manuale



### siros 100 x 50 2V

**010455.D1.01** prelucidato F3" standard dx cod. **07081001**

**010455.S1.01** prelucidato F3" standard sx cod. **07081002**

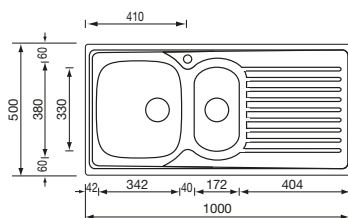

base : mm 600/mm 800 se inizio composizione  
profondità vasche : mm 160 - 100  
foro incasso : mm 975 x 475  
versione DX e SX - piletta standard manuale

#### Optionals

4.10 | 6.3 | 6.13 | 7.4 | 11.1

### siros 116 x 50 2V

**010457.D1.01** prelucidato F3" standard dx cod. **07081211**

**010457.S1.01** prelucidato F3" standard sx cod. **07081212**

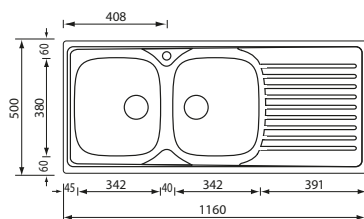

base : mm 800/mm 900 se inizio composizione  
profondità vasche : mm 160  
foro incasso : mm 1135 x 475  
versione DX e SX - piletta standard manuale

#### Optionals

4.10 | 6.3 | 6.13 | 7.4 | 11.1





# CINZIA

**cinzia Ø 43,5**

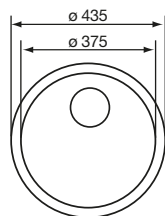

Optionals

4.11 | 6.8 | 11.1

**011949.X0.01** satinato F3" standard cod. **07020430**

base : mm 450  
 profondità vasca : mm 160  
 foro incasso : mm Ø 410  
 piletta standard manuale

**cinzia 29 x 50** vasca saldata

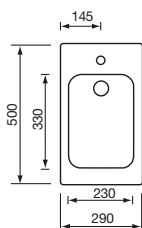

Optionals

11.1

**011932.X1.01** satinato F2" bordo h 8 cod. **07020436**

base : mm 300  
 profondità vasca : mm 160  
 foro incasso : mm 480 x 270  
 piletta standard manuale

**cinzia 44 x 50**

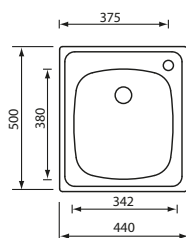

Optionals

4.10 | 6.13 | 11.1

**011934.X1.01** satinato F2" standard cod. **07020440**

**011944.X1.01** satinato F3" standard cod. **07020445**

base : mm 450  
 profondità vasca : mm 160  
 foro incasso : mm 415 x 475  
 piletta standard manuale  
**guarnizione premontata**

**cinzia 58 x 50** vasca saldata

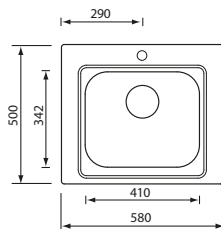













Optionals

1.1 | 3.1 | 4.4 | 6.13 | 11.1

**011945.X1.01** satinato F3" standard cod. **07020450**

base : mm 600  
 profondità vasca : mm 180  
 foro incasso : mm 560 x 480  
 piletta standard manuale

# Optionals CLASSICSTYLE

1.1	 <p><b>092000</b> <b>cod. 08711860</b> mm 342 x 410 vassoio in ABS bianco</p>	1.2	 <p><b>092011</b> <b>cod. 08711873</b> vaschetta multiuso in PPMA</p>	1.3	 <p><b>092010</b> <b>cod. 08711916</b> mm 475 x 325 economizzatore d'acqua in PPMA</p>
1.4	 <p><b>092012</b> <b>cod. 08711917</b> mm 440 x 305 economizzatore d'acqua in PPMA</p>	1.5	 <p><b>092013</b> <b>cod. 08711916A</b> mm 420 x 300 economizzatore d'acqua in PPMA</p>	2.1	 <p><b>092020</b> <b>cod. 08711870</b> mm 335 x 145 vaschetta inox forata</p>
2.3	 <p><b>092031</b> <b>cod. 08711874</b> mm 410 x 230 vaschetta inox forata</p>	3.1	 <p><b>092021</b> <b>cod. 08711850</b> mm 342 x 410 vassoio inox forato</p>	3.14	 <p><b>092026</b> <b>cod. 08711859</b> mm 340 x 405 vassoio inox forato</p>
3.15	 <p><b>092035</b> <b>cod. 08711855</b> mm 325 x 400 vassoio inox forato</p>	4.3	 <p><b>093041</b> <b>cod. 08711908</b> mm 335 x 145 cestello inox</p>	4.4	 <p><b>093080</b> <b>cod. 08711906</b> mm 400 x 325 cestello inox</p>
4.10	 <p><b>093020</b> <b>cod. 08711902</b> mm 380 x 342 cestello inox</p>	4.11	 <p><b>093050</b> <b>cod. 08711903</b> mm Ø 365 cestello inox</p>	4.13	 <p><b>093083</b> <b>cod. 08711914</b> mm 375 x 385 cestello inox</p>
6.3	 <p><b>094020</b> <b>cod. 08711807</b> prof. mm 500 tagliere scorrevole</p>	6.5	 <p><b>094062</b> <b>cod. 08711809</b> prof. mm 510 tagliere scorrevole iroko</p>	6.8	 <p><b>094011</b> <b>cod. 08711806</b> mm Ø 375 tagliere iroko</p>
6.9	 <p><b>094030</b> <b>cod. 08711810</b> mm 340 x 340 tagliere iroko</p>	6.13	 <p><b>094017</b> <b>cod. 08711866</b> mm 445 x 225 tagliere faggio</p>	7.4	 <p><b>094021</b> <b>cod. 08711816</b> prof. mm 500 tagliere scorrevole iroko con inserto PE</p>
7.5	 <p><b>094064</b> <b>cod. 08711819</b> prof. mm 510 tagliere scorrevole iroko con inserto PE</p>	7.7	 <p><b>094061</b> <b>cod. 08711833</b> mm 460 x 455 tagliere iroko con inserto PE</p>	8.3	 <p><b>094069</b> <b>cod. 08711820</b> mm 460 x 455 tagliere iroko con vaschetta inox forata</p>
8.4	 <p><b>094070</b> <b>cod. 08711832</b> prof. mm 510 tagliere scorrevole iroko con vaschetta inox forata</p>	11.1	 <p><b>093004</b> <b>cod. 08711929</b> mm 470x450 tappetino inox arrotolabile</p>		





# INDICE Miscelatori

110 : Linea **HYDRAMIX**

116 : Linea **ACQUAMIX**

131 : Linea **EASYMIX**

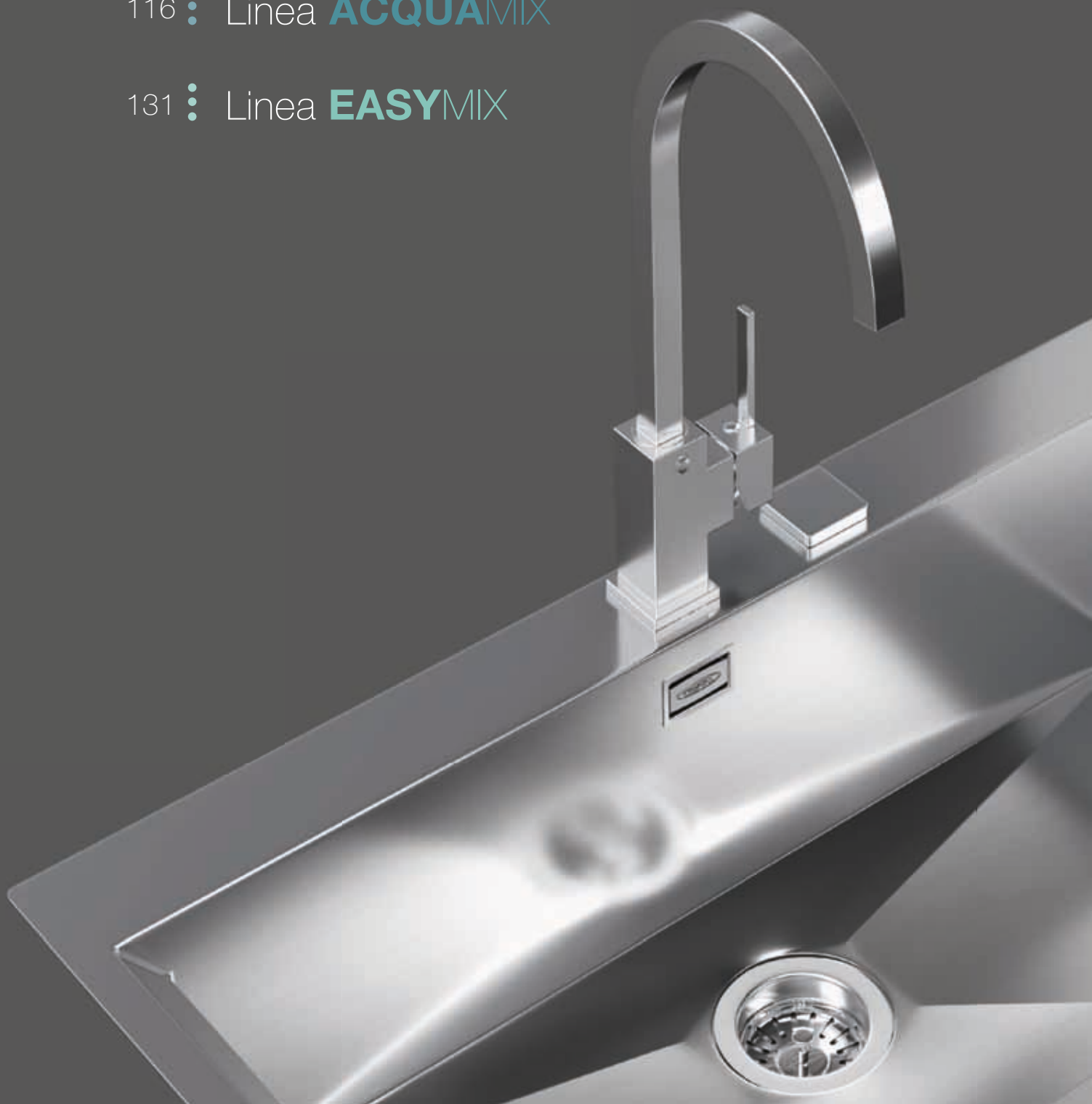

# HYDRAMIX SARDEGNA



miscelatore con canna girevole

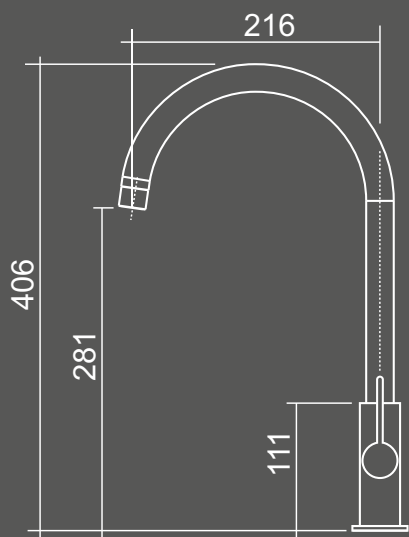

codice	ghiera	finitura	prezzo
--------	--------	----------	--------

<b>9602MISCCRM</b>	Ø mm 48	Cromato	cod. 08718115
--------------------	---------	---------	---------------



## HYDRAMIX SARDEGNA

miscelatore con canna girevole e doccia estraibile

codice	ghiera	finitura	prezzo
<b>9603MISCCRM</b>	Ø mm 48	Cromato	cod. 08718116

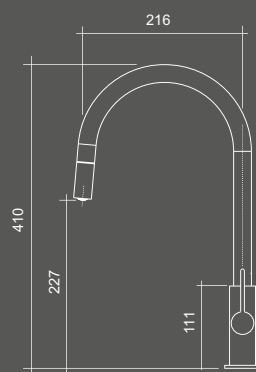

## HYDRAMIX CELTICO

miscelatore con canna nera girevole e doccia estraibile

codice	ghiera	finitura	prezzo
<b>9702MISCINOX</b>	Ø mm 50,5	Inox	cod. 08718080

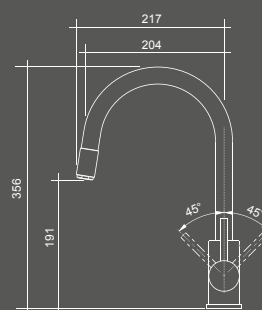

## HYDRAMIX ARTICO

miscelatore canna girevole, doccia estraibile doppio getto

codice	ghiera	finitura	prezzo
<b>9704MISCCRM</b>	Ø mm 50	Cromato	cod. 08718085

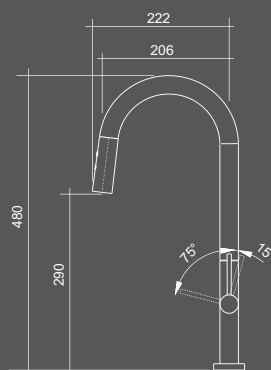

## HYDRAMIX CASPIO

miscelatore con canna girevole

codice	ghiera	finitura	prezzo
<b>9600MISCCRM</b>	Ø mm 48	Cromato	cod. 08718069

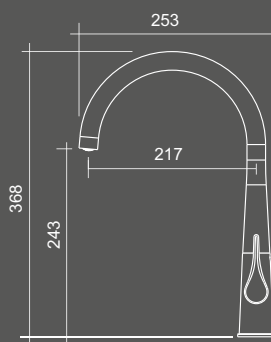

## HYDRAMIX CASPIO

miscelatore con canna girevole e doccia estraibile

codice	ghiera	finitura	prezzo
--------	--------	----------	--------

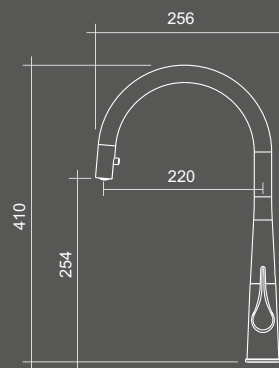

## HYDRAMIX ADRIATICO

miscelatore con canna girevole

codice	ghiera	finitura	prezzo
--------	--------	----------	--------

<b>9610MISCCRM</b>	Ø mm 50	Cromato	cod. 08718091
--------------------	---------	---------	---------------

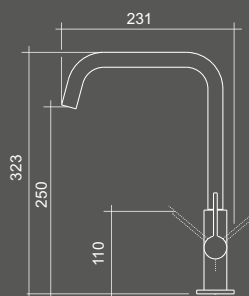

## HYDRAMIX CORALLO

miscelatore con canna girevole

codice	ghiera	finitura	prezzo
--------	--------	----------	--------

<b>9705MISCCRM</b>	Ø mm 50	Cromato	cod. 08718092
--------------------	---------	---------	---------------

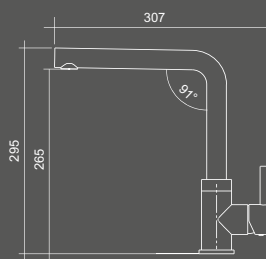

## HYDRAMIX VICTORY

miscelatore con canna girevole

codice	ghiera	finitura	prezzo
--------	--------	----------	--------

<b>9609MISCCRM</b>	Ø mm 52	Cromato	cod. 08718093
--------------------	---------	---------	---------------

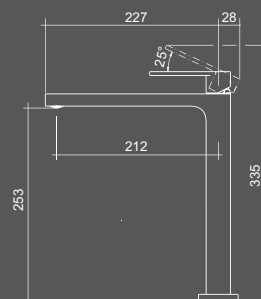

# HYDRAMIX AZOV



miscelatore con canna girevole

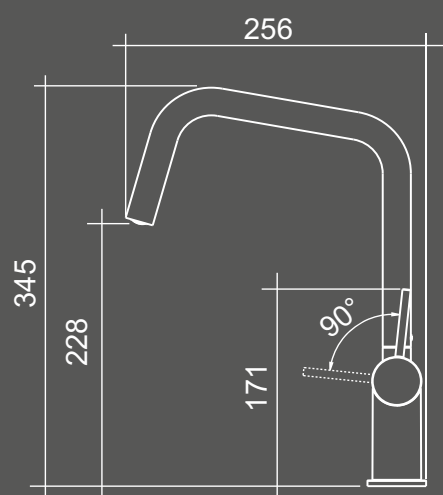

codice	ghiera	finitura	prezzo
--------	--------	----------	--------

<b>9607MISCCRM</b>	Ø mm 50	Cromato	cod. 08718090
--------------------	---------	---------	---------------

HYDRAMIX

# HYDRAMIX MARMARA

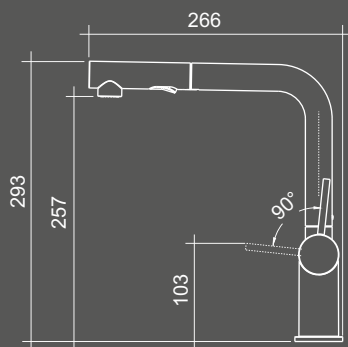

miscelatore con canna girevole, doccia estraibile doppio getto



codice	ghiera	finitura	prezzo
<b>9608MISCCRM</b>	Ø mm 55	Cromato	cod. 08718095

# HYDRAMIX BOHAI

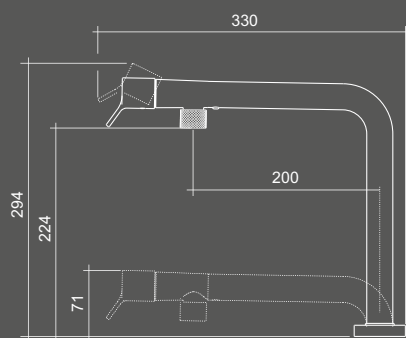

miscelatore con sistema abbattibile e comando frontale



codice	ghiera	finitura	prezzo
<b>9605MISCCRM</b>	Ø mm 55	Cromato	cod. 08718075

# HYDRAMIX IONIO

miscelatore con canna girevole

codice	ghiera	finitura	prezzo
--------	--------	----------	--------

<b>9604MISCCRM</b>	Ø mm 50	Cromato	cod. 08718088
--------------------	---------	---------	---------------

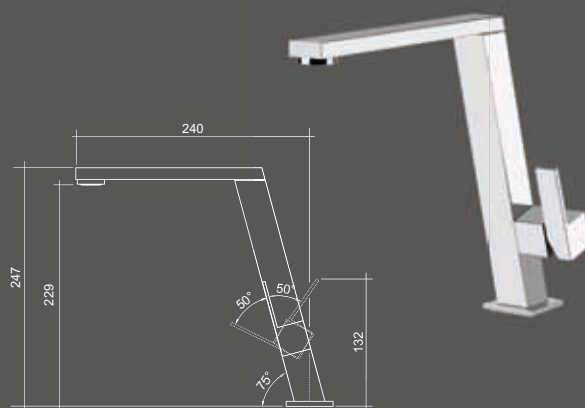

# HYDRAMIX GIAVA

miscelatore con canna girevole

codice	ghiera	finitura	prezzo
--------	--------	----------	--------

<b>9700MISCINOX</b>	Ø mm 48	Inox	cod. 08718113
---------------------	---------	------	---------------

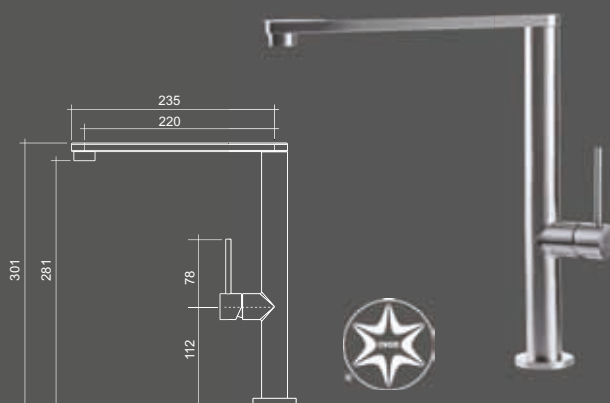

# HYDRAMIX CORSICA

miscelatore con canna girevole

codice	ghiera	finitura	prezzo
--------	--------	----------	--------

<b>9611MISCCRM</b>	Ø mm 50	Cromato	cod. 08718094
--------------------	---------	---------	---------------

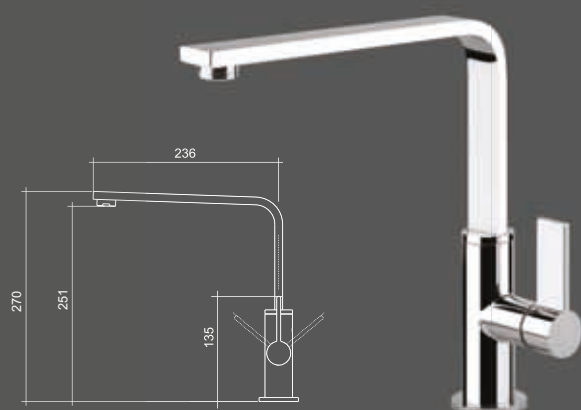



# ACQUAMIX GIGLIO



miscelatore con canna girevole

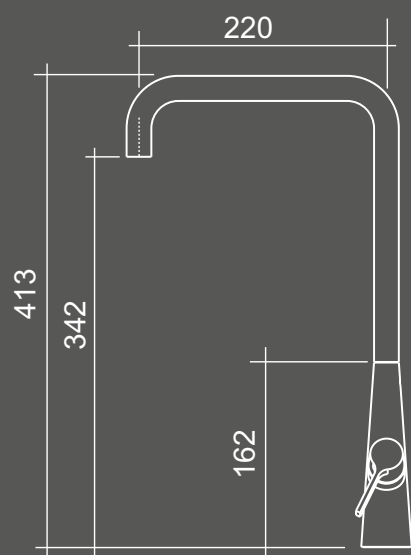

codice	corpo	finitura	prezzo
<b>9240MISCINOX</b>	Ø mm 45	Inox	cod. 08718062

# ACQUAMIX CASTELLA

miscelatore con canna girevole

codice	ghiera	finitura	prezzo
<b>9229MISCCRM</b>	Ø mm 55	Cromato	cod. 08718016

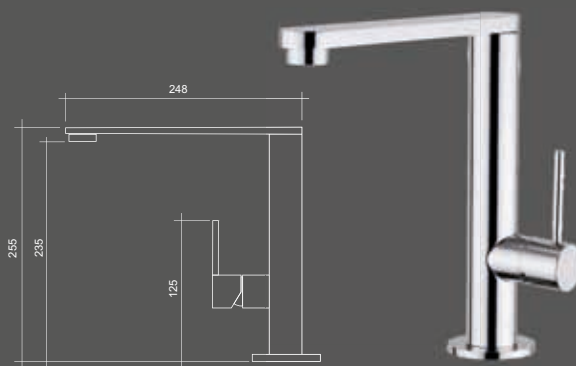

# ACQUAMIX CHERADI

miscelatore con comando remoto, canna con sistema abbattibile

codice	ghiera	finitura	prezzo
<b>9230MISCCRM</b>	ghiera canna Ø mm 50	Cromato	cod. 08718017
	ghiera comando Ø mm 50		

45 mm altezza minima raggiunta (ingombro del rubinetto con la canna abbassata)



# ACQUAMIX TREZZE

miscelatore con canna girevole e comando frontale

codice	ghiera	finitura	prezzo
<b>9109MISCCRM</b>	Ø mm 50	Cromato	cod. 08718029

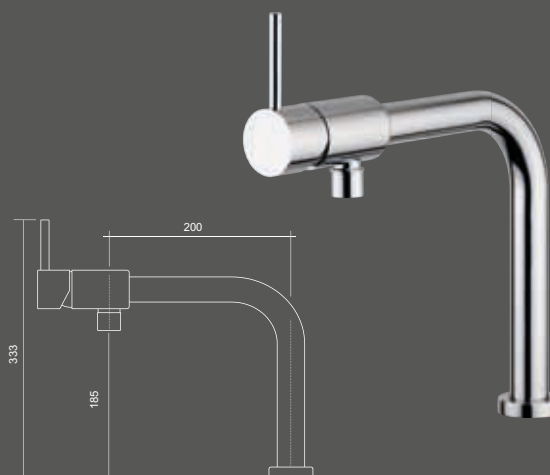

## ACQUAMIX VRACE

miscelatore con canna girevole e doccia estraibile

codice	ghiera	finitura	prezzo
<b>9226MISCCRM</b>	Ø mm 50	Cromato	cod. 08718026



## ACQUAMIX NIEDDA

miscelatore con canna girevole

codice	ghiera	finitura	prezzo
<b>9241MISCCRM</b>	mm 45	Cromato	cod. 08718063

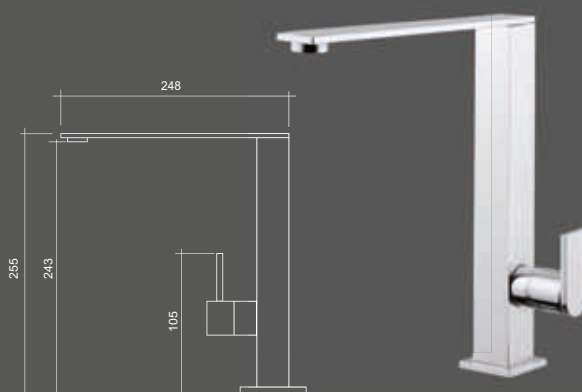

## ACQUAMIX LIPARI

miscelatore con canna girevole

codice	ghiera	finitura	prezzo
<b>9243MISCINOX</b>	Ø mm 55	Inox	cod. 08718100



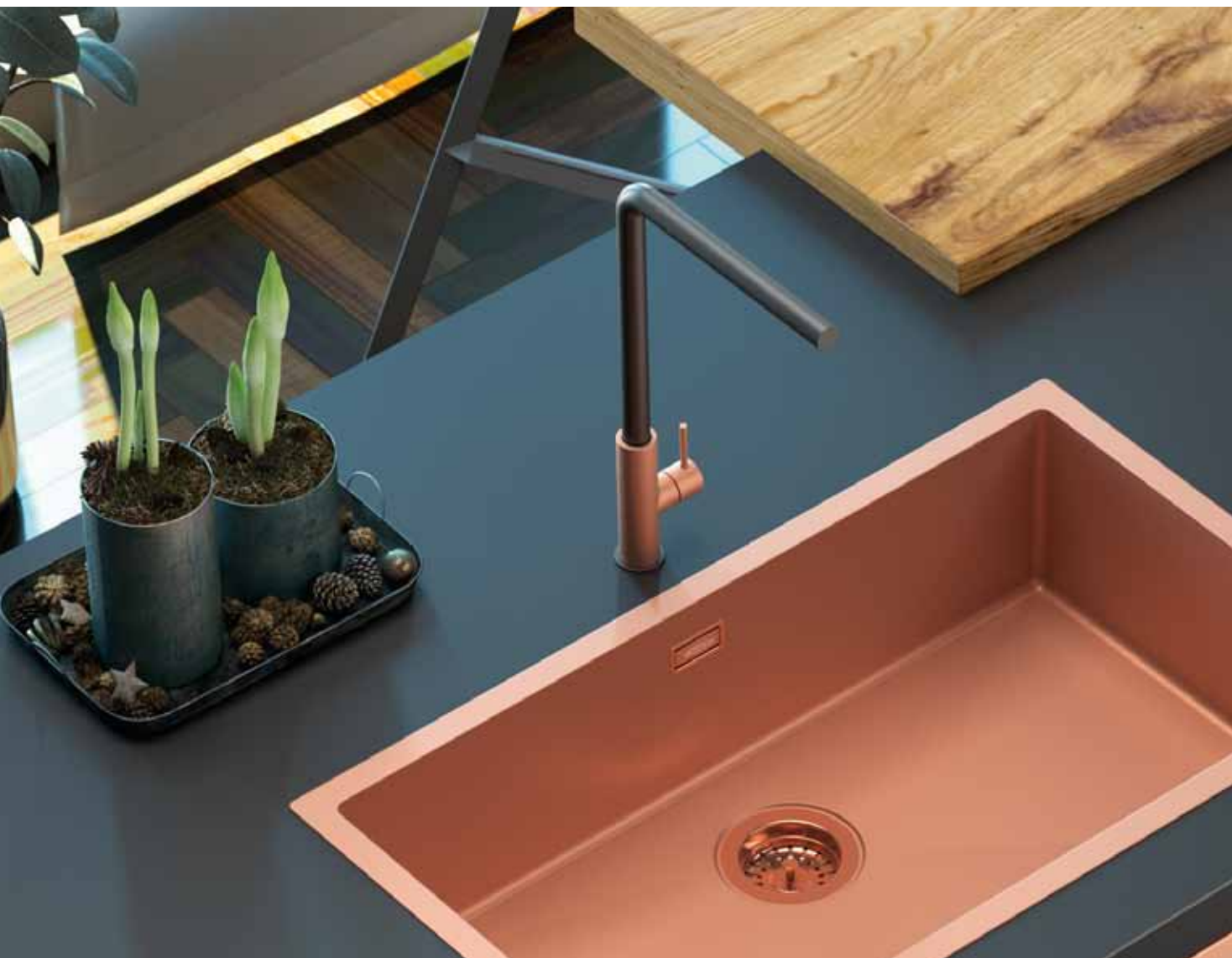

ACQUAMIX



codice	prezzo
<b>9243MISCINOX.L29</b> cod. 08718101	
<b>finitura</b> Black - copper bronze	

codice	prezzo
<b>9243MISCINOX.L79</b> cod. 08718102	
<b>finitura</b> Black - gold	

codice	prezzo
<b>9243MISCINOX.L82</b> cod. 08718103	
<b>finitura</b> Black - gun metal	

## ACQUAMIX ARVO

miscelatore con canna girevole

codice	corpo	finitura	prezzo
<b>9217MISCCRM</b>	Ø mm 45	Cromato	cod. 08718058



## ACQUAMIX SIRO

miscelatore sottofinestra

codice	ghiera	finitura	prezzo
<b>9210MISCCRM</b>	Ø mm 50	Cromato	cod. 08718047

**67 mm altezza minima raggiunta** (ingombro del rubinetto con la canna abbassata)



## ACQUAMIX TORCELLO

miscelatore con canna girevole

codice	corpo	finitura	prezzo
<b>9206MISCCRM</b>	Ø mm 45	Cromato	cod. 08718032





# ACQUAMIX LINOSA

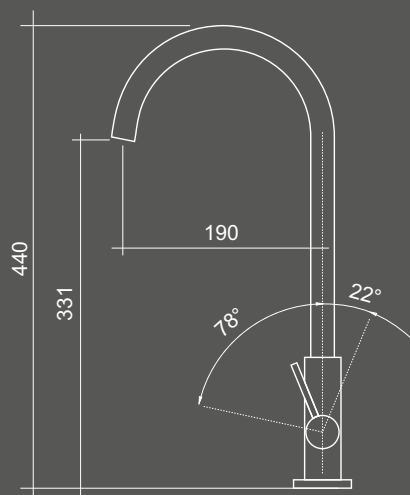

miscelatore con canna girevole



codice	ghiera	finitura	prezzo
<b>9242MISCINOX</b>	Ø mm 50	Inox	cod.08718065

ACQUAMIX



codice	prezzo
<b>9242MISCINOX.L29</b> cod. 08718066	<b>9242MISCINOX.L79</b> cod. 08718067
<b>9242MISCINOX.L82</b> cod. 08718068	
finitura Black - copper bronze	finitura Black - gold
	finitura Black - gun metal

## ACQUAMIX CIRELLA

miscelatore con canna girevole

codice	corpo	finitura	prezzo
<b>9216MISCCRM</b>	Ø mm 45	Cromato	cod. 08718052



## ACQUAMIX EGADI

miscelatore con canna girevole

codice	corpo	finitura	prezzo
<b>9214MISCCRM</b>	Ø mm 45	Cromato	cod. 08718050



## ACQUAMIX MALVA

miscelatore con canna girevole

codice	ghiera	finitura	prezzo
<b>9202MISCCRM</b>	□ mm 50	Cromato	cod. 08718004



## ACQUAMIX MARTANA

miscelatore con canna girevole e doccia estraibile

codice	ghiera	finitura	prezzo
<b>9102MISCCRM</b>	Ø mm 50	Cromato	cod. 08718000

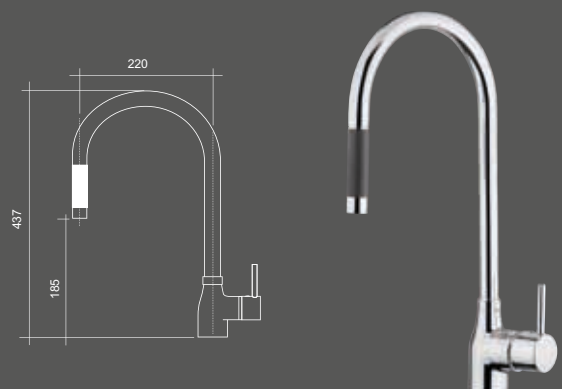

# ACQUAMIX MARTANA



miscelatore con canna girevole e doccia estraibile

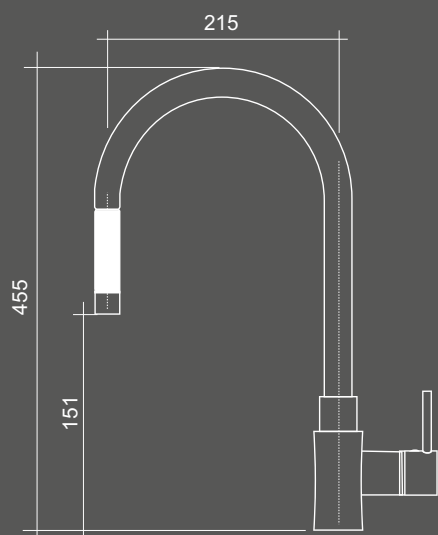

codice	ghiera	finitura	prezzo
<b>9102MISCINOX</b>	Ø mm 50	Inox	cod. 08718001

ACQUAMIX

## ACQUAMIX MILO

miscelatore con canna girevole

codice	ghiera	finitura	prezzo
<b>9231MISCCRM</b>	Ø mm 55	Cromato	cod. 08718019

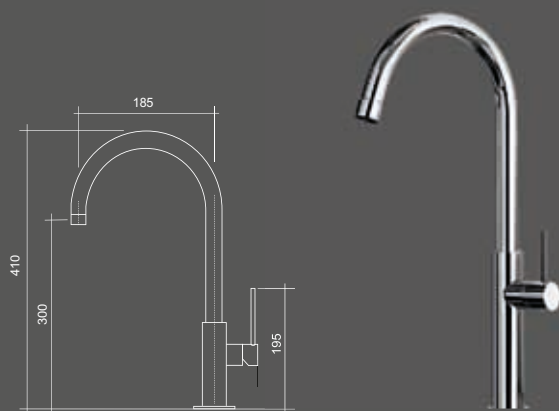

## ACQUAMIX ISCHIA

miscelatore con canna girevole

codice	ghiera	finitura	prezzo
<b>9208MISCCRM</b>	Ø mm 50	Cromato	cod. 08718024



## ACQUAMIX CAPRI

miscelatore con canna girevole

codice	corpo	finitura	prezzo
<b>9213MISCCRM</b>	Ø mm 45	Cromato	cod. 08718012



## ACQUAMIX SANTORINI

miscelatore con mollettone, particolari neri, leva minimalista e doccia due getti

codice	ghiera	finitura	prezzo
<b>9108MISCCRM</b>	Ø mm 55	Cromato	cod. 08718073

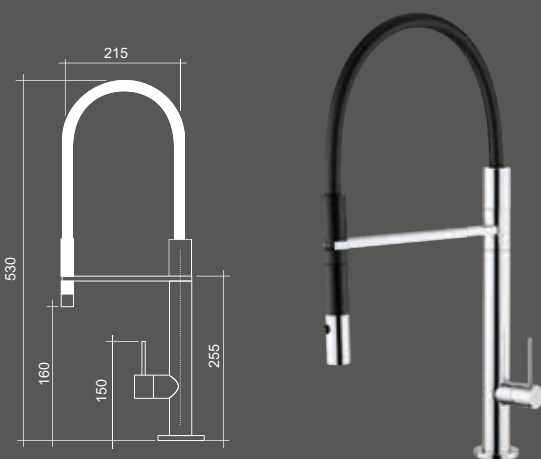

# ACQUAMIX PANAREA

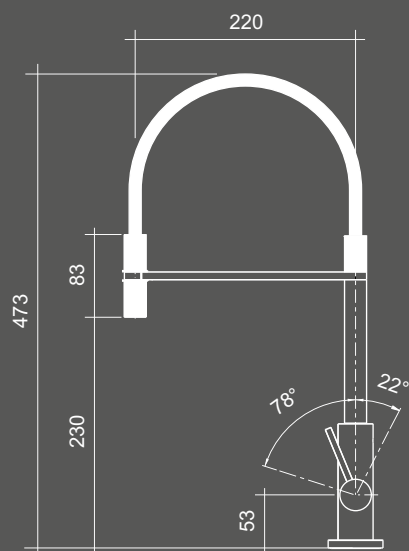

miscelatore canna girevole con mollettone, doccia e particolari neri



codice ghiera finitura prezzo

**9244MISCINOX** Ø mm 55 Inox cod. 08718105



codice  
**9244MISCINOX.L29** cod. 08718106

finitura Black - copper bronze

codice  
**9244MISCINOX.L79** cod. 08718107

finitura Black - gold

codice  
**9244MISCINOX.L82** cod. 08718108

finitura Black - gun metal



# ACQUAMIX PONZA



miscelatore con mollettone e doccia due getti

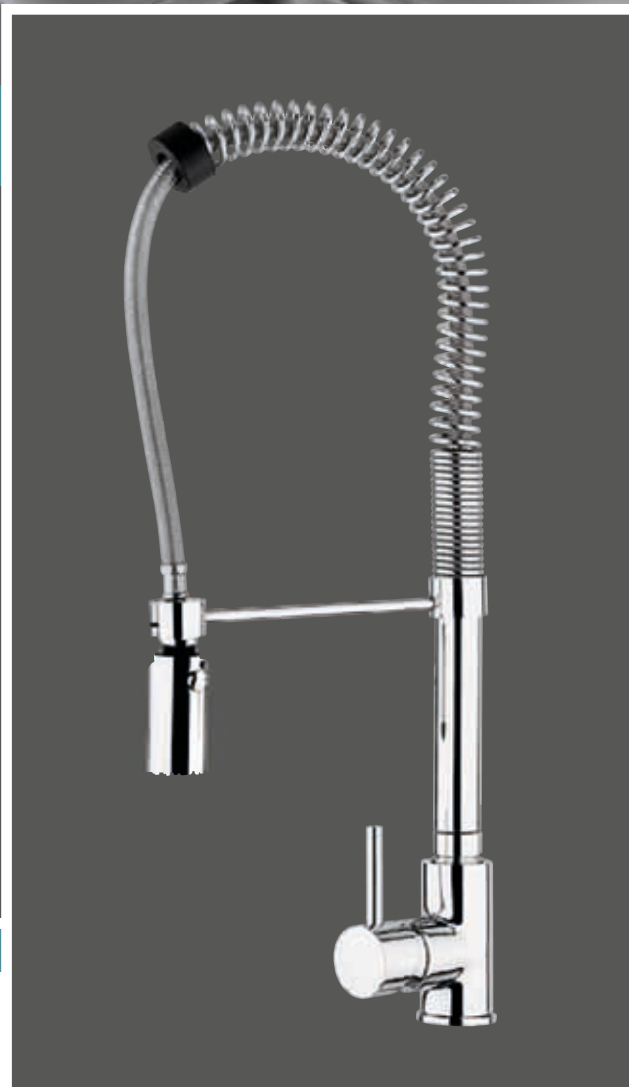
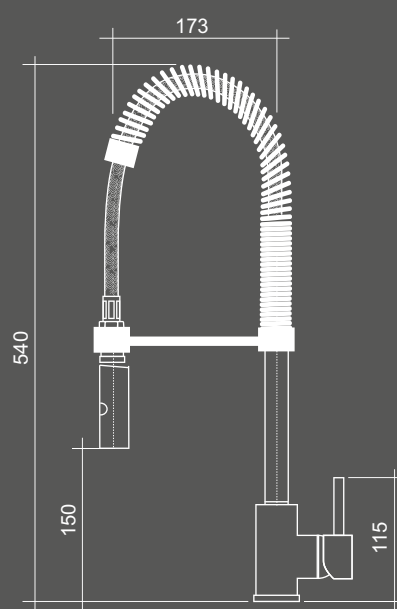

codice	ghiera	finitura	prezzo
<b>9105MISCCRM</b>	Ø mm 50	Cromato	cod. 08718045

# ACQUAMIX GALLIPOLI

miscelatore con corpo girevole

codice	ghiera	finitura	prezzo
<b>9203MISCCRM</b>	Ø mm 50	Cromato	cod. 08718006

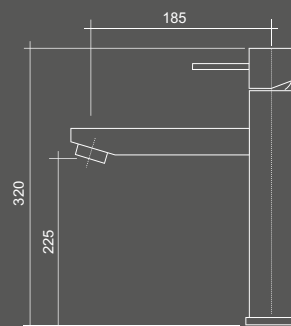

# ACQUAMIX GARDA

miscelatore con canna girevole

codice	ghiera	finitura	prezzo
<b>9101MISCCRM</b>	Ø mm 50	Cromato	cod. 08718049

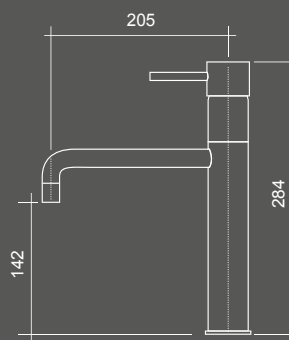

# ACQUAMIX RIACI

miscelatore con mollettone e doccia due getti

codice	ghiera	finitura	prezzo
<b>9220MISCCRM</b>	Ø mm 50	Cromato	cod. 08718046

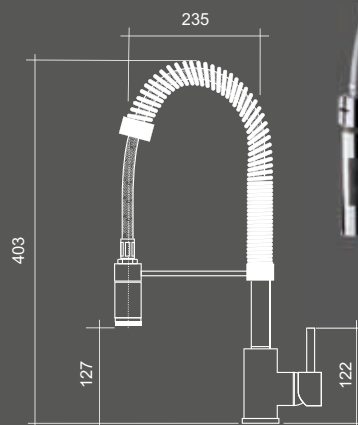

# ACQUAMIX GIUDECCA



miscelatore con canna girevole

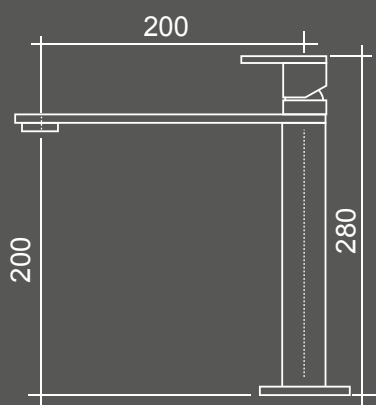

codice	ghiera	finitura	prezzo
<b>9106MISCCRM</b>	Ø mm 50	Cromato	cod. 08718022

# ACQUAMIX KING

miscelatore con doccia estraibile

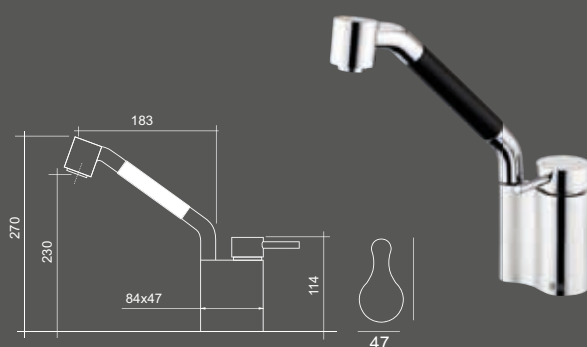

codice	corpo	finitura	prezzo
<b>9233MISCCRM</b>	mm 84X47	Cromato	cod. 08718027

Prodotto non installabile sui modelli:  
Vesta - Evoluzione - Brando - Punto quadro - ClassicStyle

# ACQUAMIX ORENUS

miscelatore con doccia estraibile, due getti

codice	ghiera	finitura	prezzo
<b>9222MISCCRM</b>	Ø mm 50	Cromato	cod. 08718053

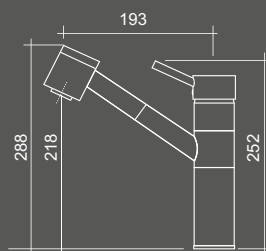

# ACQUAMIX BURANO

miscelatore con doccia estraibile

codice	ghiera	finitura	prezzo
<b>9205MISCCRM</b>	Ø mm 50	Cromato	cod. 08718030

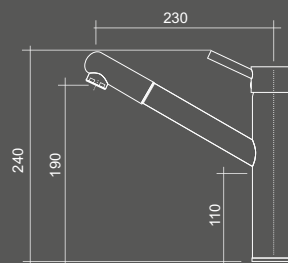

# ACQUAMIX BURANO

miscelatore con canna girevole

codice	ghiera	finitura	prezzo
<b>9300MISCCRM</b>	Ø mm 50	Cromato	cod. 08718061

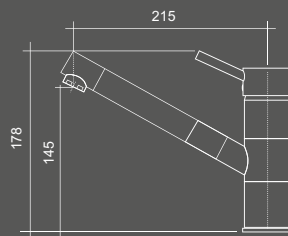

# ACQUAMIX GALEA

miscelatore con doccia estraibile, due getti

codice	ghiera	finitura	prezzo
<b>9221MISCCRM</b>	Ø mm 55	Cromato	cod. 08718034

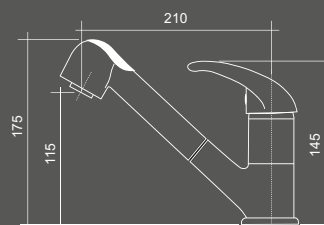

# ACQUAMIX DEVA

miscelatore con canna girevole

codice	ghiera	finitura	prezzo
<b>9207MISCCRM</b>	Ø mm 50	Cromato	cod. 08718036

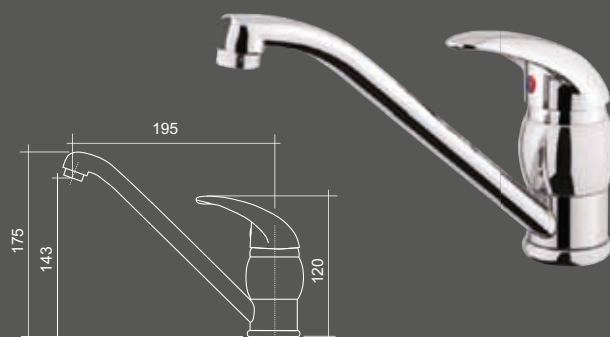

# ACQUAMIX VIVARA

miscelatore con canna girevole

codice	ghiera	finitura	prezzo
<b>9211MISCCRM</b>	Ø mm 50	Cromato	cod. 08718010



# ACQUAMIX ITACA

miscelatore con canna girevole

codice	ghiera	finitura	prezzo
<b>9209MISCCRM</b>	Ø mm 50	Cromato	cod. 08718008





# EASYMIX DESE

miscelatore con canna girevole

codice	ghiera	finitura	prezzo
90301MISCCRM	Ø mm 51	Cromato	cod. 08718110

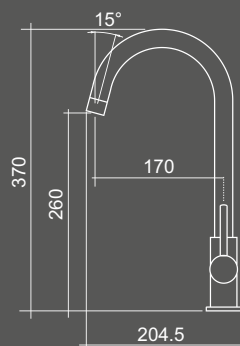

# EASYMIX RENO

miscelatore con canna girevole

codice	ghiera	finitura	prezzo
90208MISCCRM	Ø mm 55	Cromato	cod. 08718111

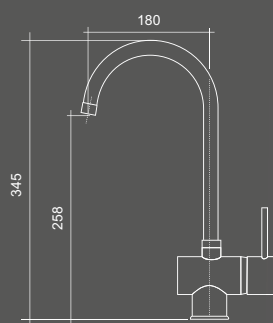

# EASYMIX DORA

miscelatore con canna girevole

codice	corpo	finitura	prezzo
90216MISCCRM	Ø mm 48	Cromato	cod. 08718081

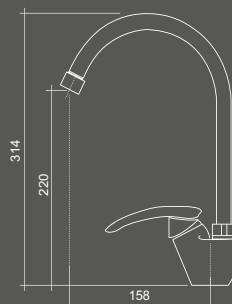

# EASYMIX FLY

miscelatore con canna girevole e doccia estraibile

codice	ghiera	finitura	prezzo
90226MISCINOX	Ø mm 51	Inox	cod. 08718082

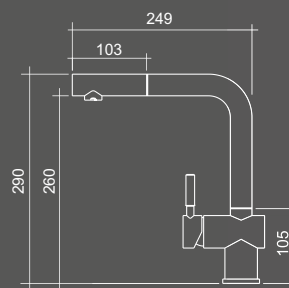

# Components

dispencer

**091002** cod. 08711918

dispencer cromato tondo per sapone/detersivo liquido



dissipatore inox per rifiuti alimentari

**097902** cod. 08711922

dissipatore inox 3/4 HP pileta tonda, con pulsante PVC cromato

potenza 3/4 HP (550W)  
peso 6.3 Kg  
pileta 3"



Il dissipatore per rifiuti alimentari CM si colloca facilmente sotto i lavelli e consente di ridurre in particelle i rifiuti organici che saranno poi smaltiti nello scarico in modo comodo, sicuro e silenzioso. Una soluzione ottimale per mantenere igiene e pulizia in cucina.

buffel inox cleaner

**097061** cod. 08711925

f acone da 250 ml - pulisce, cura e protegge l'acciaio inox



panno microfibra (cm 40 x 40)

**097062** cod. 08711926

confezione da 5 pezzi





Il Ns. Servizio Clienti è a Vostra disposizione dal Lunedì al Venerdì  
dalle ore 8.00 alle ore 12.00 e dalle ore 14.00 alle ore 18.00



CM S.p.A. si riserva la facoltà di apportare modifiche in qualsiasi momento, senza l'obbligo di preavviso.

CM S.p.A. declina ogni responsabilità per eventuali errori o inesattezze.

Sono vietate le riproduzioni per fini commerciali di immagini e disegni senza autorizzazione da parte di CM S.p.A.

I prodotti CM S.p.A. sono certificati nel rispetto della normativa europea .



**LUBE INDUSTRIES SRL**

Via dell'Industria, 4 - 62010 Treia (MC) Italia  
Tel. centralino 0733 8401 (r.a.)  
Fax 0733 840222 - 0733 840333  
info@cucinelube.it - www.cucinelube.it  
info@creokitchens.it - www.creokitchens.it

La Lube Industries srl è dotata di Sistemi di Gestione per l'Efficienza Ambientale, per la Qualità e per la Salute e la Sicurezza sul lavoro, in conformità alle norme: UNI EN ISO 14001, UNI EN ISO 9001 e UNI EN ISO 45001. Per maggiori informazioni visita il nostro sito [www.cucinelube.it](http://www.cucinelube.it)