

Il modello Iris rilegge con spirito contemporaneo i temi più classici del vivere in cucina, creando sofisticate atmosfere che possono essere coniugate anche per la zona living. L'anta dal disegno tradizionale a telaio è arricchita da una serie di varianti colore assolutamente attuali e di moda. Iris è un modello di cucina assolutamente straordinario, con forte personalità, pronto a soddisfare le diverse esigenze nell'ambiente cucina, sia di gusto che di funzionalità, per creare pregiate composizioni in stile tradizionale assolutamente originali ed inedite.



The Iris model provides a contemporary look to most classical kitchen styles, creating sophisticated atmospheres that can also be combined with the living area. The traditional framed door design is enriched by a series of extremely contemporary and fashionable colour variations. Iris is an extraordinary kitchen model with a strong personality. It is ready to satisfy different needs in a kitchen space, in terms of both taste and functionality, in order to create refined traditional compositions with an original and unusual style.

SP. 20 MM

CARATTERISTICHE TECNICHE

ANTE	telaio in massello di frassino sp. 20 mm con bugna impiallacciata frassino nei colori: bianco camelia a poro aperto (opz.606), bianco caldo a poro aperto (opz.2455), grigio traffico a poro aperto (opz.244S), lino a poro aperto (opz.247S)
ANTE VETRO	telaio in massello di frassino sp. 20 mm nei colori: bianco camelia a poro aperto (opz.606T), bianco caldo a poro aperto (opz.2455T), grigio traffico a poro aperto (opz.244ST), lino a poro aperto (opz.247ST), vetro temperato extrachiaro sp.4 mm filo grezzo serigrafato effetto tessuto in vernice satinata
FRONTALE CASSETTI	in massello di frassino nei colori: bianco camelia a poro aperto (opz.606), bianco caldo a poro aperto (opz.2455), grigio traffico a poro aperto (opz.244S), lino a poro aperto (opz.247S)
MANIGLIE	vedi pag.14
STRUTTURE DI SERIE	<p>ANTA: bianco camelia nobilitato conchiglia (opz.8910) schiena e ripiano conchiglia (opz.8910)</p> <p>ANTA: bianco caldo nobilitato bianco (opz.001) schiena e ripiano bianco (opz.001)</p> <p>ANTA: lino nobilitato lino effetto tela (opz.8920) schiena e ripiano conchiglia (opz.8910)</p> <p>ANTA: grigio traffico nobilitato grigio effetto tela (opz.9695) schiena e ripiano argilla (opz.9690)</p>
MENSOLE	<p>di serie: altezza cm 3,8 in laminato colore bianco (opz.001), argilla (opz.9690), conchiglia (opz.8910)</p> <p>a richiesta: altezza cm 3,8 impiallacciate finitura come ante</p>
ZOCCOLI	vedi pag.15



TH. 20 MM

TECHNICAL SPECIFICATIONS

DOORS	solid wood frame in ash th. 20 mm with ash veneered central panel in the following finishes: open-pore camellia white (opt.606), open-pore warm white (opt.2455), open-pore traffic grey (opt.244S), open-pore inen (opt.247S)
GLASS DOORS	solid wood frame in ash th. 20 mm in the following finishes: open-pore camellia white (opt.606T), open-pore warm white (opt.2455T), open-pore traffic grey (opt.244ST), open-pore inen (opt.247ST), extra-clear tempered glass th.4 mm ground edges with fabric-effect screen printing with satin-finish paint
DRAWERS FRONT	in solid ash in the following finishes: open-pore camellia white finish (opt.606), open-pore warm white (opt.2455), open-pore traffic grey (opt.244S), open-pore inen (opt.247S)
HANDLES	see page 14
STANDARD CARCASSES	DOOR: camellia white melamine-coated shell (opt.8910), shell back panel and shelf (opt.8910) DOOR: warm white melamine-coated white (opt.001), white back panel and shelf (opt.001) DOOR: linen linen melamine-coated canvas effect (opt.8920) shell back panel and shelf (opt. 8910) DOOR: traffic grey grey melamine-coated canvas effect (opt.9695) clay back panel and shelf (opt. 9690)
SHELVES	standard: height 3.8 cm, laminam colour white (opt.001), clay (opt.9690), shell (opt.8910) on request: height 3.8 cm, veneered same finishes as doors
PLINTHS	see page 15

cod. **K13** SP. 20 MM
TH. 20 MM

iris

ante doors



bianco camelia
a poro aperto (opz.606)
open-pore camellia white
(opt.606)



bianco caldo (opz.2455)
warm white (opt.2455)



lino (opz.247S)
linen (opt.247S)



grigio traffico (opz.244S)
traffic grey (opt.244S)

SP. 20 MM TH.20 MM

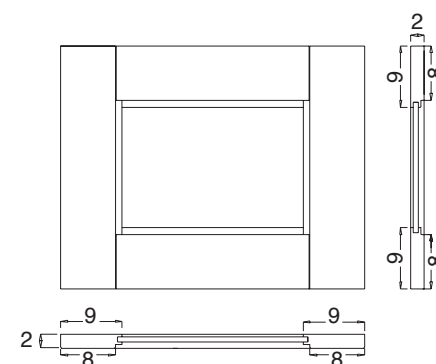

cod. **K13** SP. 20 MM
TH. 20 MM

iris

ante vetro glass doors

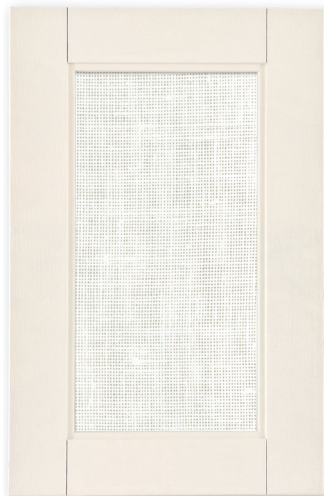

bianco camelia
a poro aperto (opz.606T),
con vetro temperato
extrachiario filo grezzo effetto
tessuto in vernice satinata
open-pore camellia white
(opt.606T), extra-clear tempered
glass, ground edges, fabric effect
with satin-finish paint

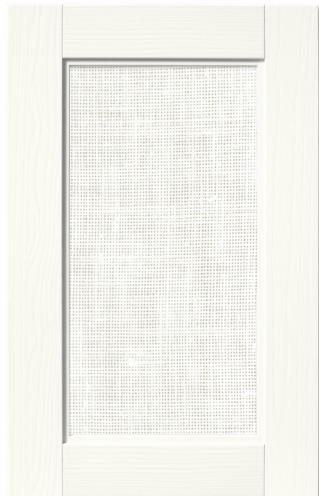

bianco caldo (opz.2455T),
con vetro temperato
extrachiario filo grezzo effetto
tessuto in vernice satinata
warm white (opt.2455T),
extra-clear tempered glass,
ground edges, fabric effect
with satin-finish paint



lino (opz.247ST),
con vetro temperato
extrachiario filo grezzo effetto
tessuto in vernice satinata
linen (opt.247ST),
extra-clear tempered glass,
ground edges, fabric effect
with satin-finish paint

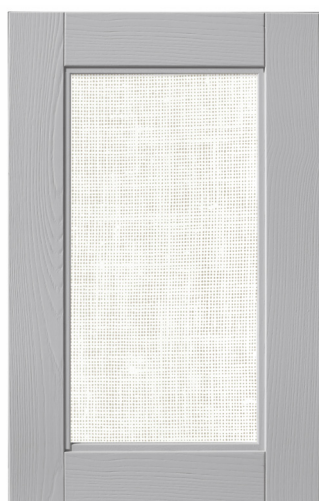

grigio traffico (opz.244ST),
con vetro temperato
extrachiario filo grezzo effetto
tessuto in vernice satinata
traffic grey (opt.244ST),
extra-clear tempered glass,
ground edges, fabric effect
with satin-finish paint

SP. 20 MM TH.20 MM

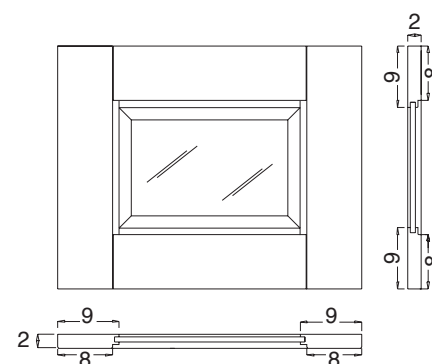

MANIGLIE HANDLES

DI SERIE STANDARD



Maniglia K82 finitura nichel satinato
anta L 30 a L 90 → passo 128 mm

Handle K82 satin nickel finish
door W 30 to W 90 → centre-to-centre distance 128 mm



Pomo K82P finitura nichel satinato
passo 32 mm
utilizzata per elementi da 15 con maniglia K82

Knob K82P satin nickel finish
centre-to-centre distance 32 mm
used for W 15 elements with handle K82

A RICHIESTA ON REQUEST



Maniglia 591G finitura grigio selce
anta L 15 → passo 96 mm
anta L 30 a L 45 → passo 160 mm
anta da L 60 a L 120 → passo 320 mm

Handle 591G flint grey finish
door W 15 → centre-to-centre distance 96 mm
door W 30 to W 45 → centre-to-centre distance 160 mm
door from W 60 to W 120 → centre-to-centre distance 320 mm

A RICHIESTA ON REQUEST



Maniglia K82G finitura ghisa
anta L 30 a L 90 → passo 128 mm

Handle K82G cast iron finish
door W 30 to W 90 → centre-to-centre distance 128 mm



Pomo K82GP finitura ghisa
passo 32 mm
utilizzata per elementi da 15 con maniglia K82G

Knob K82GP cast iron finish
centre-to-centre distance 32 mm
used for W 15 elements with handle K82G

A RICHIESTA ON REQUEST



Maniglia 57BA finitura bronzo anticato
anta L 15 → passo 12 mm
anta L 30 a L 45 → passo 160 mm
anta da L 60 a L 120 → passo 320* mm

Handle 57BA antiqued bronze finish
door W 15 → centre-to-centre distance 12 mm
door W 30 to W 45 → centre-to-centre distance 160 mm
door from W 60 to W 120 → centre-to-centre distance 320* mm

A RICHIESTA ON REQUEST



Maniglia 156 finitura argento antico
passo 96 mm
Handle 156 antique silver finish
centre-to-centre distance 96 mm



Pomo 435 finitura argento
Knob hole 435 silver finish

A RICHIESTA ON REQUEST



Maniglia 556T finitura grigio titanio
anta L 15 → pomo
anta L 30 a L 45 → passo 160 mm
anta da L 60 a L 120 → passo 320* mm

Handle 556T titanium grey finish
door W 15 → knob
door W 30 to W 45 → centre-to-centre distance 160 mm
door from W 60 to W 120 → centre-to-centre distance 320* mm



Pomo finitura grigio titanio
utilizzato per elementi da 15
con maniglia 556T

Knob titanium grey finish
used for 15 cm elements with handle 556T

A RICHIESTA ON REQUEST



Maniglia 255R finitura rame antico
passo 160 mm
Handle 255R antique copper finish
160 mm centre-to-centre distance



Pomo 255RP finitura rame antico
utilizzato per elementi da 15
con maniglia 255R
Knob hole 255RP antique copper finish
used for 15 cm elements with handle 255R

A RICHIESTA ON REQUEST



Maniglia 255N finitura nichel satinato
passo 160 mm
Handle 255N nickel satin finish
160 mm centre-to-centre distance



Pomo 255NP finitura nichel satinato
utilizzato per elementi da 15
con maniglia 255N
Knob hole 255NP nickel satin finish
used for 15 cm elements with handle 255N

strutture carcasses



bianco (opz.001)
schiena e ripiano bianco
(opz.001)
white (opt.001)
white back panel and shelf
(opt.001)



conchiglia (opz.8910)
schiena e ripiano conchiglia
(opz.8910)
shell (opt.8910)
shell back panel and shelf
(opt.8910)



grigio effetto tela (opz.9695)
schiena e ripiano argilla (opz.9690)
grey melamine-coated canvas
effect (opt.9695)
clay back panel and shelf
(opt.9690)



lino effetto tela (opz.8920)
schiena e ripiano conchiglia
(opz.8910)
linen melamine-coated canvas
effect (opt.8920)
shell back panel and shelf (opt.8910)



GREENGUARD
LE STRUTTURE DELLE CUCINE SONO CONTRADDISTINTE DALLA CERTIFICAZIONE GREENGUARD, PER SODDISFARE GLI STANDARD PIU' RIGOROSI IN TERMINI DI LIVELLI DI EMISSIONE DI COMPOSTI ORGANICI VOLATILI (COV).

mensole in laminato laminated shelves



bianco (opz.001)
white (opt.001)

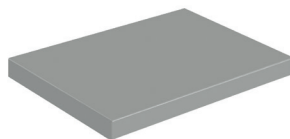

argilla (opz.9690)
clay (opt.9690)

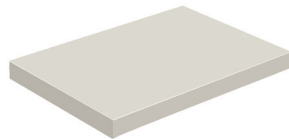

conchiglia (opz.8910)
shell (opt.8910)

mensole impialacciate veneered shelves



impialacciata come anta
N.B.: per le finiture vedi colore ante pag.12
veneered same finish as door
Note: for the finishes see door colours see page 12

zoccoli in pvc H 13 pvc plinths H 13



bianco (opz.2455)
white (opt.2455)



alluminio finitura
conchiglia (opz.7403)
aluminium shell
finish (opt.7403)



alluminio grigio
traffico (opz.9511)
aluminium traffic grey
finish (opt.9511)



alluminio lino
(opz.W770)
aluminium linen
(opt.W770)

di serie
standard

zoccolo in alluminio H 13 aluminium plinth H 13



alluminio finitura
ottone (opz.7761)
aluminium brass
finish (opt.7761)



alluminio finitura
ghisa (opz.9509)
aluminium cast iron
finish (opt.9509)



alluminio finitura titanio
ossidato (opz.414)
aluminium titanium
oxidized finish (opt.414)



alluminio finitura rame
anticato (opz.422)
aluminium antique
copper finish (opt.422)



alluminio finitura
silver dark (opz.9507)
aluminium dark silver
finish (opt.9507)

cornici cappello top cornices



frassino bianco (opz.2455)
ash white (opt.2455)



frassino lino (opz.247S)
ash linen (opt.247S)



frassino camelia (opz.606)
ash camelia (opt.606)

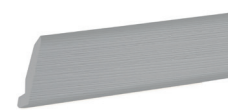

frassino grigio traffico (opz.244S)
ash traffic grey (opt.244S)

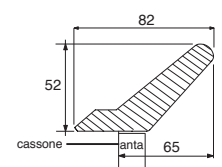

sezione cornice
frame cross-section

MODULARITÀ E COMPONIBILITÀ MODULARITY AND FITTING SOLUTIONS

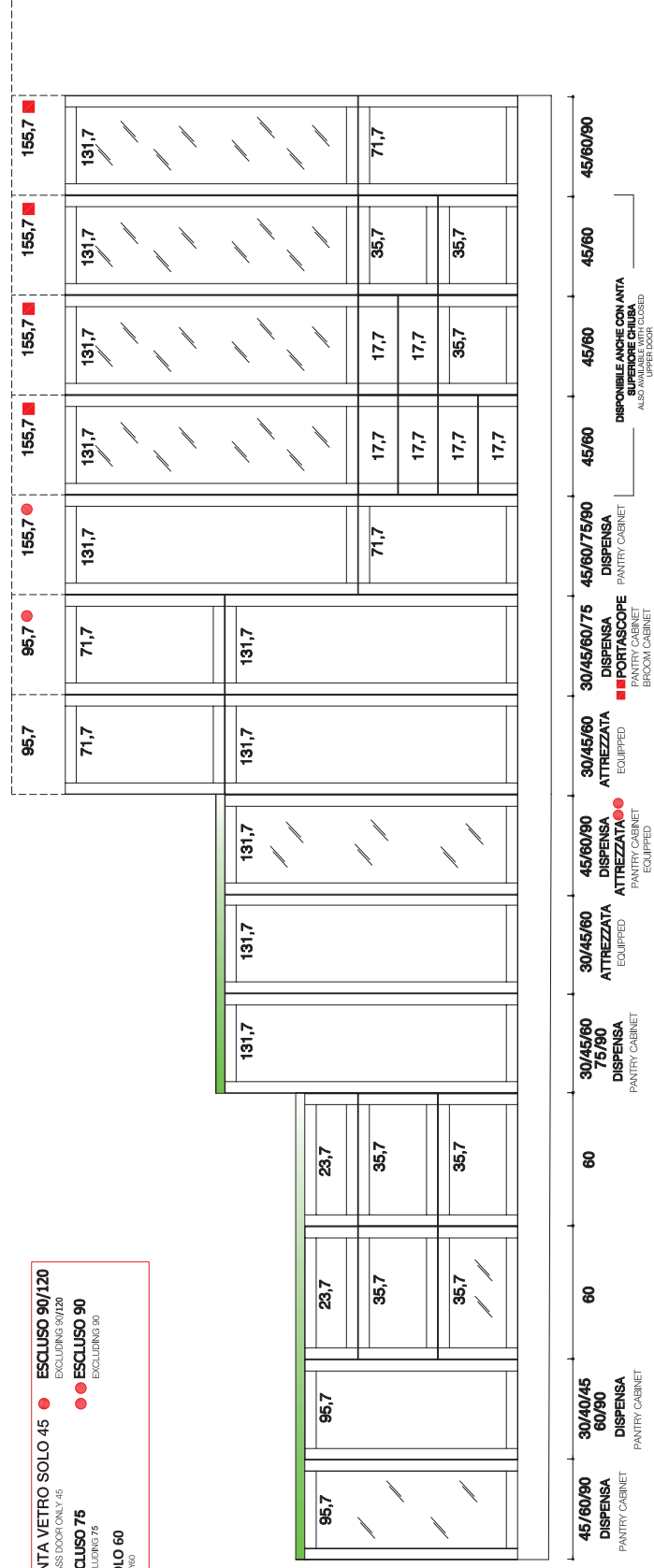
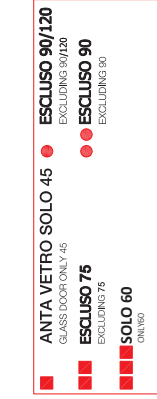
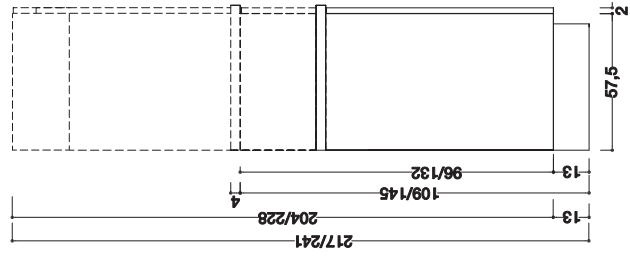
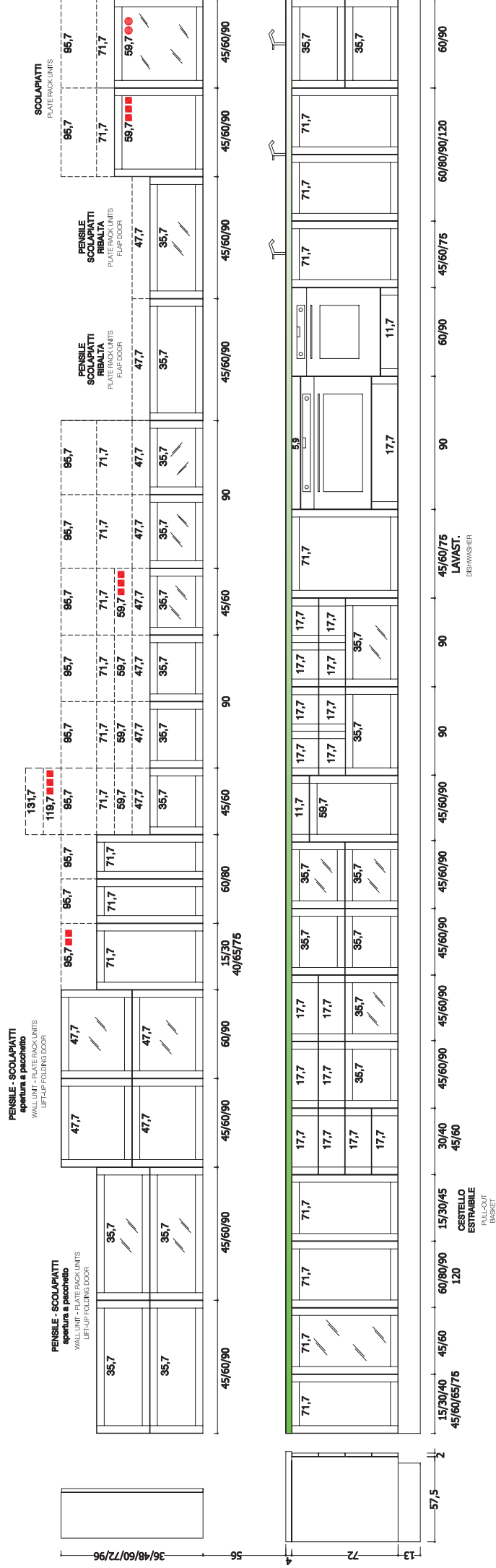

MODULARITÀ E COMPONIBILITÀ MODULARITY AND FITTING SOLUTIONS

BASI H 73
BASE UNITS H 73

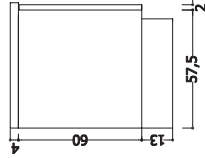

BASI SOSEPE
HANGING BASE UNITS

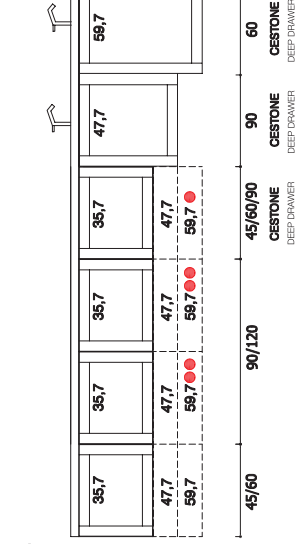
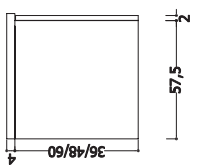

BASI LIVING
LIVING BASE UNITS

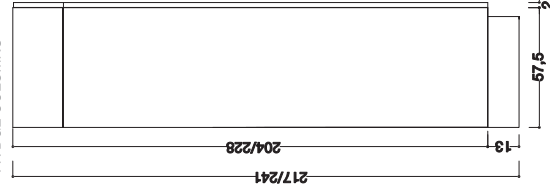
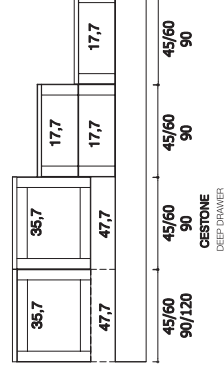
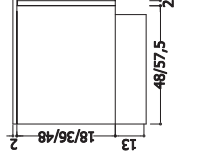

COLONNE FRIGO
FRIDGE COLUMNS

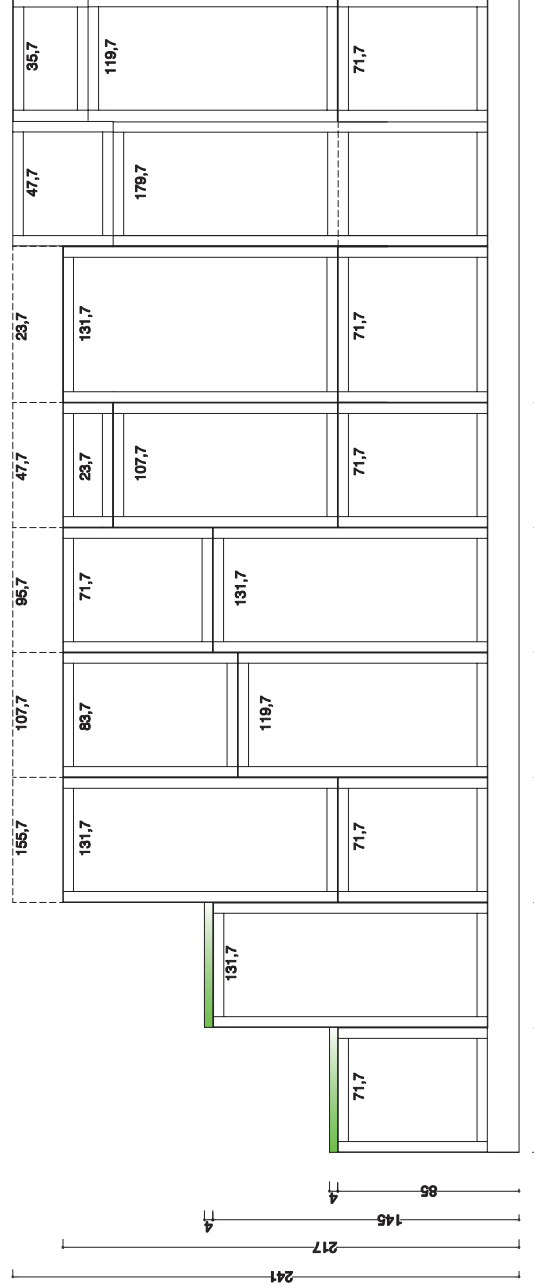

● ESCLUSO 90
EXCLUDING 90

● ESCLUSO 120
EXCLUDING 120

COLONNE FORNO
OVEN COLUMNS

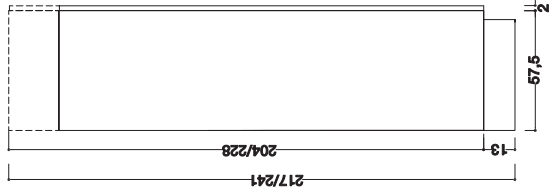

PENSILI RIBALTA CHIUSURA AMMORTIZZATA

FLAP DOOR WALL UNITS BLUMOTION CLOSING SYSTEM

PENSILE CON APERTURA A RIBALTA

Le ante aprendosi verso l'alto consentono di avere un' ampia visione d'insieme all'interno del mobile. In questo modo è possibile un comodo accesso agli oggetti contenuti al suo interno e, dal punto di vista ergonomico, molto vantaggioso. La regolazione della forza di apertura può essere impostata in modo esatto in base al peso del frontale. Grazie all'arresto progressivo le ante si fermano in qualsiasi posizione; in questo modo la maniglia è sempre facilmente raggiungibile. La chiusura è ammortizzata di serie.

WALL UNIT WITH FLAP DOOR

The doors that open upwards guarantee ample overall visibility inside the cabinet. In this way, all objects housed inside the cabinet can be comfortably accessed, making the system highly advantageous from an ergonomic perspective. The opening force can be adjusted precisely according to the weight of the front. The doors stop in any position thanks to the gradual stopping movement; in this way, the handle is always easily accessible. The closing movement is cushioned standard

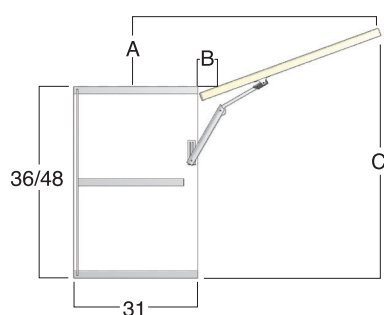

	A	B	C
H 36	10	2,3	46
H 48	13	2,3	61

PENSILI APERTURA A PACCHETTO

WALL UNITS FOLDING DOORS

PENSILE CON APERTURA ANTE A PACCHETTO

Il meccanismo d'apertura ante a pacchetto è idoneo sia sul pensile H 72 che H 96; la regolazione della forza di apertura può essere impostata in modo esatto in base ai pesi dei frontali, la chiusura è ammortizzata e la cerniera centrale clip si contraddistingue per l'innovativa tecnologia che garantisce la sicurezza per le dita.

WALL UNIT WITH LIFT-UP FOLDING DOORS

The lift-up folding door opening mechanism is suitable for wall units with H 72 or H 96; the opening force can be adjusted precisely according to the weight of the fronts, while the closing movement is cushioned and the central clip-on hinge features innovative technology for safeguarding the fingers.



H 72



H 96

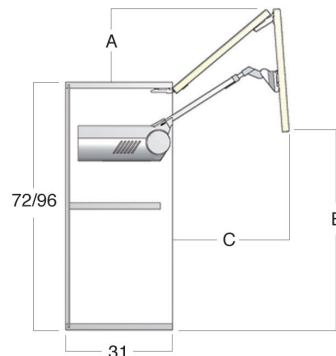

	A	B	C
H 72	19,5	54	41
H 96	24,7	69	53

SCHEMA MONTAGGIO LIMITATORE LIMITER INSTALLATION DIAGRAM

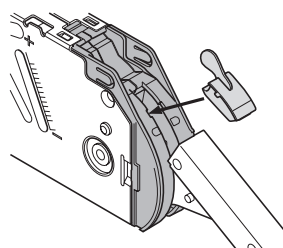
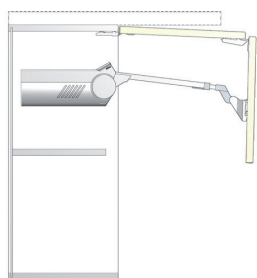

Per evitare l'interferenza dell'anta in fase di apertura con cornici o mensole, si può richiedere il limitatore dell'angolo di apertura cod. 5620005

In order to avoid that the door interferes with cornices or shelves during the opening movement, it is possible to request an opening angle limiter: code 5620005

TIPOLOGIE CAPPE CAMINO

CHIMNEY HOOD TYPES

cappa tipo "E"
vedi pag. 40

chimney type "E"
see page 40



SCHEMA CAPPА CAMINETTO AD ANGOLO

CORNER CHIMNEY HOOD DIAGRAM

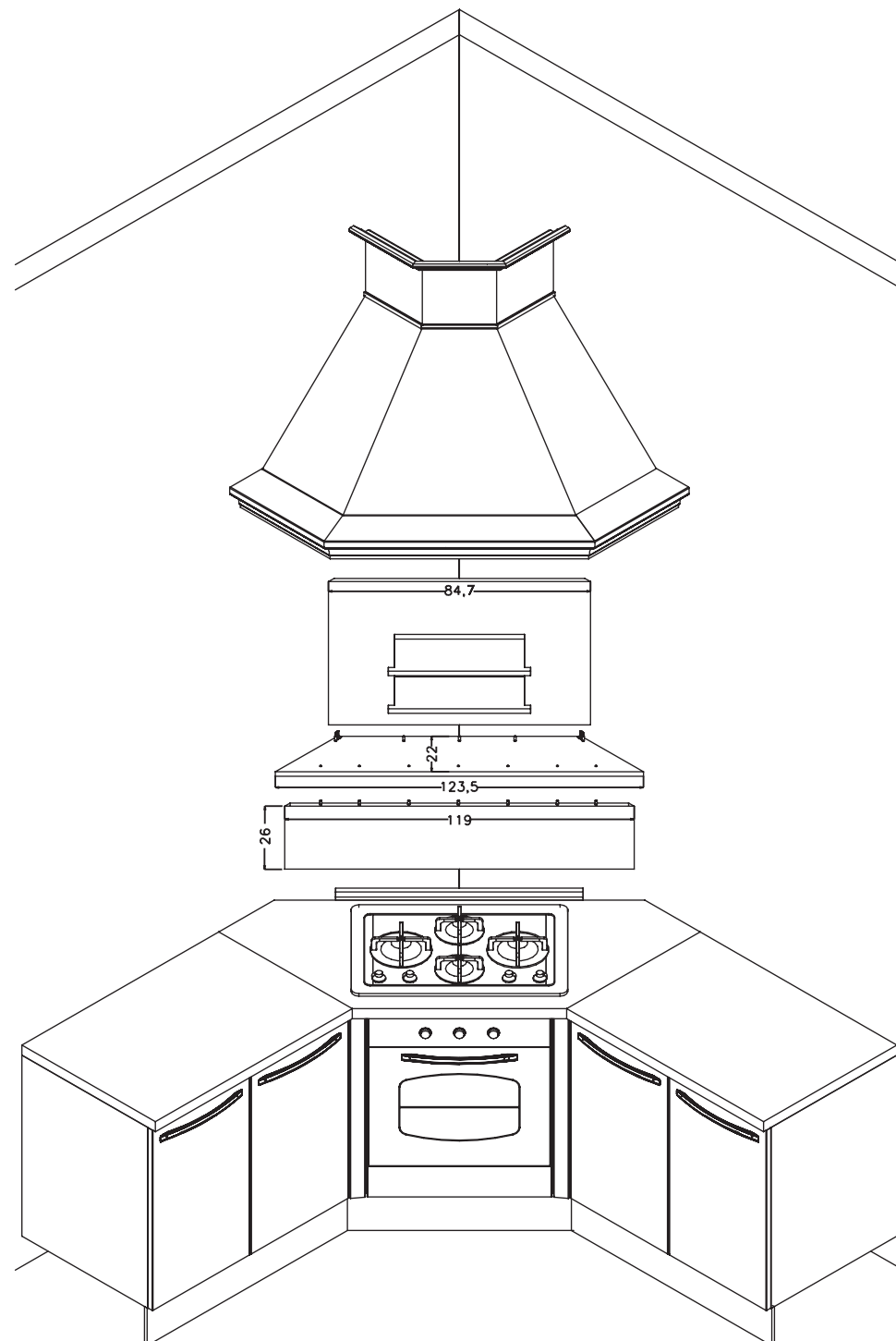

SCHEMA CAPPА CAMINETTO AD ANGOLO

CORNER CHIMNEY HOOD DIAGRAM

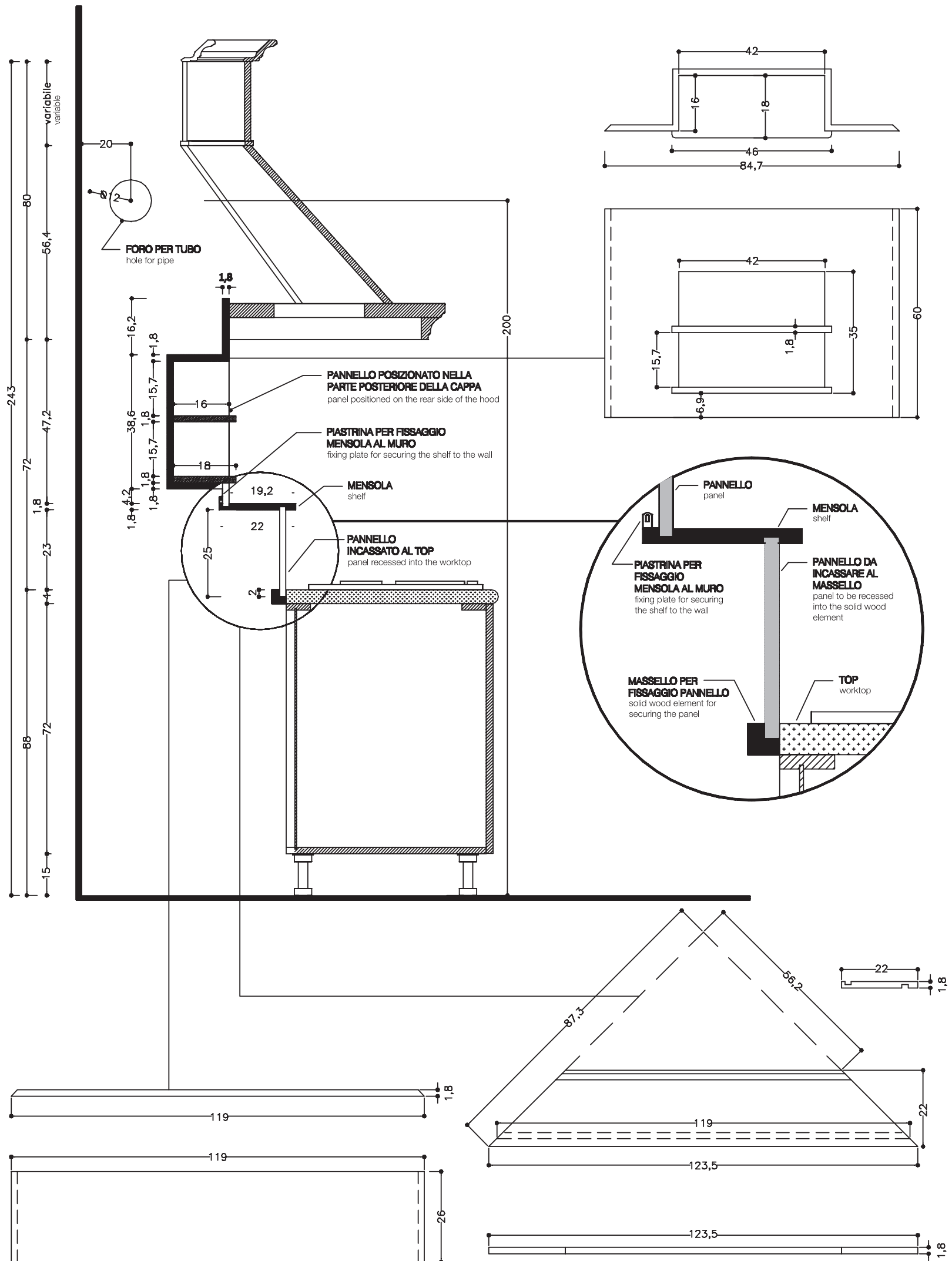

ISOLA IN LEGNO

WOOD ISLAND

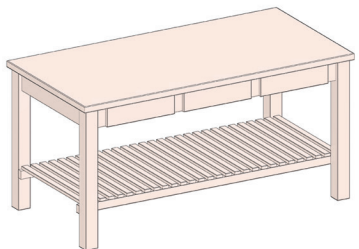
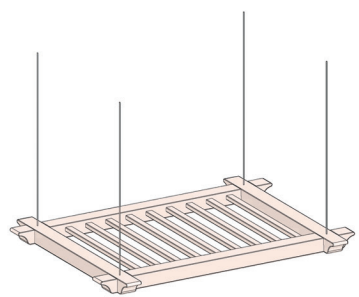

	COD.	IRIS					
<p>isola in legno con 3 cassetti e ripiano grigliato colore come anta wood island with 3 drawers and wire shelf same colour as door</p> 		K13					
	L 180 H 89 P 90	E4951100					
<p>elemento sopra isola in legno colore come anta wood over island unit same colour as door</p> 							
	L 120 H 6 P 90	08605980					

LIVING

Spazi coordinati per avere un solo ambiente per cucinare, ricevere gli amici, pranzare e rilassarsi è una soluzione al desiderio di vivere la casa più liberamente, secondo stili di vita contemporanei, integrando cucina e living all'insegna di un nuovo linguaggio progettuale.

Coordinated spaces that create a single environment in which to cook, receive friends and relax is a solution that allows you to experience the home more freely.

In line with contemporary lifestyles, this solution integrates the kitchen and living area to create a new design language



COMPOSIZIONE BASSA L 255

LOW COMPOSITION W 255



COMPOSIZIONE BASSA L 300

LOW COMPOSITION W 300



COMPOSIZIONE BASSA L 255

LOW COMPOSITION W 255

COMPONENTI COMPONENTS

Colonna 60 H 219 frigo-freezer 315 classe F

60 cm column H 219 fridge-freezer 315 class "F"

Base 45 2 cassetti e cestone

45 cm base unit with 2 drawers and deep drawer

Base 60 forno statico inox con ventilazione tangenziale di raffreddamento

stainless steel static oven with orbital cooling ventilation 60 base unit

Piano cottura 60 4 gas inox con valvola di sicurezza

60 cm stainless steel hob with 4 gas burners with safety valve

Sottolavello 90

90 cm sink unit

Lavello ad incasso 86 x 50 1 vasca inox prelucidato

86x50 cm built-in sink with 1 stainless steel bowl

Pensile vetro 45 H 72

45 cm glass wall unit H 72

Cappa 60 aspirante estraibile H 63 1 motore

60 cm hood slide-out ducting H 63 1 motor

Scolapiatti 90 H 72

90 cm plate rack H 72

Top 195 P 61 in laminato H 4

195 cm laminate worktop D 61 H 4

Cornice cappello ml 3,71

3,71 lm top cornice

Asta appendipensili ml 2

2 lm wall unit fixing strip

(Elettrodomestici Beko)
(Beko appliances)

IRIS

COMPOSIZIONE BASSA L 300

LOW COMPOSITION W 300

COMPONENTI COMPONENTS

Colonna 60 H 219 frigo-freezer 315 classe F

60 cm column H 219 fridge-freezer 315 class "F"

Base 60 2 cassetti e cestone

60 cm base unit with 2 drawers and deep drawer

Base 60 forno statico inox con ventilazione tangenziale di raffreddamento

stainless steel static oven with orbital cooling ventilation 60 base unit

Piano cottura 60 4 gas inox con valvola di sicurezza

60 cm stainless steel hob with 4 gas burners with safety valve

Base 60

60 cm base unit

Sottolavello 60

60 cm sink unit

Lavello ad incasso 86 x 50 1 vasca inox prelucidato

86x50 cm built-in sink with 1 stainless steel bowl

Pensile 60 H 72

60 cm wall unit H 72

Cappa 60 aspirante estraibile H 63 1 motore

60 cm hood slide-out ducting H 63 1 motor

Pensile 60 H 72

60 cm wall unit H 72

Scolapiatti 60 H 72

60 cm plate rack H 72

Top 240 P 61 in laminato H 4

240 cm laminate worktop D 61 H 4

Cornice cappello ml 4,16

4,16 lm top cornice

Asta appendipensili ml 4

4 lm wall unit fixing strip

(Elettrodomestici Beko)
(Beko appliances)

IRIS

COMPOSIZIONE ALTA L 300

HIGH COMPOSITION W 300



COMPOSIZIONE BASSA L 360

LOW COMPOSITION W 360



COMPOSIZIONE ALTA L 300

HIGH COMPOSITION W 300

COMPONENTI COMPONENTS

Colonna 60 H 243 frigo-freezer 315 classe F

60 cm column H 243 fridge-freezer 315 class "F"

Base 60 2 cassetti e cestone

60 cm base unit with 2 drawers and deep drawer

Base 60 forno statico inox con ventilazione tangenziale di raffreddamento

stainless steel oven with orbital cooling ventilation 60 base unit

Piano cottura 60 4 gas inox con valvola di sicurezza

60 cm stainless steel hob with 4 gas burners with safety valve

Base 60

60 cm base unit

Sottolavello 60

60 cm sink unit

Lavello ad incasso 86 x 50 1 vasca inox prelucidato

86x50 cm built-in sink with 1 stainless steel bowl

Pensile 60 H 72

60 cm wall unit H 72

Cappa 60 aspirante estraibile H 63 1 motore

60 cm hood slide-out ducting H 63 1 motor

Pensile 60 H 96

60 cm wall unit H 96

Scolapiatti 60 H 96

60 cm plate rack H 96

Top 240 P 61 in laminato H 4

240 cm laminate worktop D 61 H 4

Mensola 120 P 31 sp. 3,8

120 cm shelf D 31 sp. 3,8

Cornice cappello ml 4,16

4,16 lm top cornice

Asta appendipensili ml 4

4 lm wall unit fixing strip

(Elettrodomestici Beko)

(Beko appliances)

IRIS

COMPOSIZIONE BASSA L 360

LOW COMPOSITION W 360

COMPONENTI COMPONENTS

Colonna 60 H 219 frigo-freezer 315 classe F

60 cm column H 219 fridge-freezer 315 class "F"

Colonna 60 H 111 con cestone, forno statico inox con ventilazione tangenziale di raffreddamento

60 column H.111 with deep drawer configured for stainless steel static oven with orbital cooling ventilation

Base 90 2 cassetti + cestone predisposto P.C.

90 cm base unit with 2 drawers + deep drawer configured for hob

Piano cottura 60 4 gas inox con valvola di sicurezza

60 cm stainless steel hob with 4 gas burners with safety valve

Base 60

60 cm base unit

Sottolavello 90

90 cm sink unit

Lavello ad incasso 86 x 50 1 vasca inox prelucidato

86x50 cm built-in sink with 1 stainless steel bowl

Pensile 60 H 72

60 cm wall unit H 72

Cappa 90 caminetto tipo "E"

90 chimney hood type "E"

Pensile 60 H 72

60 cm wall unit H 72

Scolapiatti 90 H 72

90 cm plate rack H 72

Top 240 P 61 in laminato H 4

240 cm laminate worktop D 61 H 4

Top 60 P 61 in laminato H 4

60 cm laminate worktop D 61 H 4

Mensola 90 P 31 SP 3,8

90 cm shelf D 31 SP 3,8

Cornice cappello ml 4,76

4,76 lm top cornice

Asta appendipensili ml 4

4 lm wall unit fixing strip

(Elettrodomestici Beko)

(Beko appliances)

IRIS