

# selma

Modello caratterizzato da un' anta a telaio da 22 mm, dalla pregiata lavorazione per un design pulito ed attualissimo nei toni delicati dei colori laccati su frassino a poro aperto.

Il tradizionale concetto di anta a telaio viene riletto e aggiornato, con la speciale maniglia che nasce dalla raffinata sagomatura del traverso superiore. Innovativa ed elegante Selma trasmette emozioni con le sue laccature raffinate e moderne che personalizzano e danno eleganza con preziosi dettagli di luce. La conformazione dell'anta a telaio e la maniglia incorporata, ne valorizzano la leggerezza e la praticità, per arredare con stile la propria cucina e la zona living.





## CREO ECOLOGIC

IL GRUPPO LUBE HA SCELTO DI UTILIZZARE PER I COMPONENTI COSTITUENTI LE STRUTTURE DELLE CUCINE SOLO MATERIALE A BASSISSIMA EMISSIONE DI FORMALDEIDE: CONFORMI ALLO STANDARD F4STELLE SECONDO LA NORMA JIS, CERTIFICATO DAL MINISTERO GIAPPONESE, IL PIU' SEVERO IN MERITO ALLE NORMATIVE DI SALVAGUARDIA AMBIENTALE.

Regarding the production of its kitchen structure components, lube group has decided to only use materials featuring very low formaldehyde emissions complying with the 4-star standard, as defined by the jis regulation. This standard is certified by the japanese government-the most rigorous when it comes to environmental protection.

With its 22 mm framed door, high value finish, clean and modern design, stands out for its delicate lacquered colours and open-pore ash panels. The traditional concept of door and frame is reinterpreted with the handle emerging from the refined profiling of the upper frame member. Innovative and elegant, Selma evokes emotions with its refined and modern lacquering, for a personal, refined design with delicate details of light. The framed door and the recessed handle values the lightness and the convenience to furnish ones kitchen and living with style.

## CARATTERISTICHE TECNICHE

ANTE	intelaiate sp.22 mm in massello di frassino con bugna impiallacciata frassino fiamma orizzontale nei colori: laccato bianco a poro aperto (opz.2471), laccato lino a poro aperto (opz.247S), laccato grigio traffico a poro aperto (opz.244S), laccato verde fiordo a poro aperto (opz.2474)
FRONTALI CASSETTI	in massello di frassino liscio sp.22 mm fiamma orizzontale laccato a poro aperto nei colori: bianco (opz.2471), lino (opz.247S), grigio traffico (opz.244S), verde fiordo (opz.2474)
ANTE VETRO	intelaiata sp.22 mm in massello di frassino nei colori: laccato bianco a poro aperto (opz.2471F), laccato lino a poro aperto (opz.247SF), laccato grigio traffico a poro aperto (opz.244SF), laccato verde fiordo a poro aperto (opz.2474F), vetro temperato fumè sp.4 mm
MANIGLIA	<b>presa maniglia inclusa sull'anta lato orizzontale con profilo tipo "A"</b>
STRUTTURE DI SERIE	<p><b>ANTA: FRASSINO BIANCO</b> nobilitato bianco (opz.001), schiena e ripiano bianco (opz.001)</p> <p><b>ANTA: FRASSINO GRIGIO TRAFFICO</b> nobilitato argilla (opz.9690), schiena e ripiano argilla (opz.9690)</p> <p><b>ANTE: FRASSINO LINO, FRASSINO VERDE FIORDO</b> nobilitato conchiglia (opz.8910), schiena e ripiano conchiglia (opz.8910)</p>
MENSOLE	<b>vedi pag.16</b>
ZOCCOLI	<b>vedi pag.17</b>



---

## TECHNICAL SPECIFICATIONS

---

DOORS	22 mm solid ash frame with horizontal grain ash veneered central panel, colours: open-pore white lacquered (opt.2471), open-pore linen lacquered (opt.247S), open-pore traffic grey lacquered (opt.244S), open-pore fiordo green lacquered (opt.2474)
DRAWER FRONT	22 mm smooth solid ash, lacquered, with open-pore horizontal grain, colours: white (opt.2471), linen (opt.247S), traffic grey (opt.244S), fiordo green (opt.2474)
GLASS DOORS	22 mm solid ash frame, colours: open-pore white lacquered (opt.2471F), open-pore linen lacquered (opt.247SF), open-pore traffic grey lacquered (opt.244SF), open-pore fiordo green lacquered (opt.2474F), smoky tempered glass th.4 mm
HANDLE	handle grip included on horizontal side of the door with A profile
STANDARD CARCASSES	<b>DOOR: WHITE ASH</b> melamine-coated white (opt.001), white back panel and shelf (opt.001)  <b>DOOR: TRAFFIC GREY ASH</b> melamine-coated pearl (opt.9690), pearl panel and shelf (opt.9690)  <b>DOORS: LINEN ASH, FIORDO GREEN ASH</b> melamine-coated shell (opt.8910), shell back panel and shelf (opt.8910)
SHELVES	see page 16
PLINTHS	see page 17

---

## ante doors

 *colori in pronta consegna  
available colours*



**frassino laccato bianco  
a poro aperto (opz.2471)**  
open-pore white lacquered  
ash (opt.2471)



**frassino laccato lino  
a poro aperto (opz.247S)**  
open-pore linen lacquered  
ash (opt.247S)



**frassino laccato grigio traffico  
a poro aperto (opz.244S)**  
open-pore traffic grey  
lacquered ash (opt.244S)



**frassino laccato verde fiordo  
a poro aperto (opz.2474)**  
open-pore fiordo green  
lacquered ash (opt.2474)

## cestoni deep drawers



**frassino laccato bianco  
a poro aperto (opz.2471)**  
open-pore white lacquered  
ash (opt.2471)



**frassino laccato lino  
a poro aperto (opz.247S)**  
open-pore linen lacquered  
ash (opt.247S)



**frassino laccato grigio traffico  
a poro aperto (opz.244S)**  
open-pore traffic grey  
lacquered ash (opt.244S)



**frassino laccato verde fiordo  
a poro aperto (opz.2474)**  
open-pore fiordo green  
lacquered ash (opt.2474)

## cassetti drawers



**frassino laccato bianco  
a poro aperto (opz.2471)**  
open-pore white lacquered  
ash (opt.2471)



**frassino laccato lino  
a poro aperto (opz.247S)**  
open-pore linen lacquered  
ash (opt.247S)



**frassino laccato grigio traffico  
a poro aperto (opz.244S)**  
open-pore traffic grey  
lacquered ash (opt.244S)



**frassino laccato verde fiordo  
a poro aperto (opz.2474)**  
open-pore fiordo green  
lacquered ash (opt.2474)

**SP. 22 MM TH.22 MM**

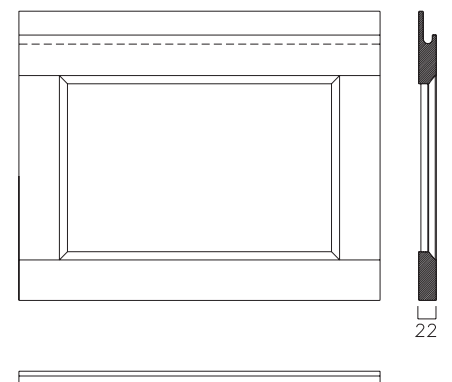

## ante vetro glass doors

 *colori in pronta consegna  
available colours*



telaio frassino laccato bianco a poro aperto (opz.2471F), vetro fumè  
open-pore white lacquered ash frame (opt.2471F), smoke glass



telaio frassino laccato lino a poro aperto (opz.247SF), vetro fumè  
open-pore linen lacquered ash frame (opt.247SF), smoke glass



telaio frassino laccato grigio traffico a poro aperto (opz.244SF), vetro fumè  
open-pore traffic grey lacquered ash frame (opt.244SF), smoke glass



telaio frassino laccato verde fiordo a poro aperto (opz.2474F), vetro fumè  
open-pore fiordo green lacquered ash frame (opt.2474F), smoke glass

## cestoni vetro glass deep drawers



telaio frassino laccato bianco a poro aperto (opz.2471F), vetro fumè  
open-pore white lacquered ash frame (opt.2471F), smoke glass



telaio frassino laccato lino a poro aperto (opz.247SF), vetro fumè  
open-pore linen lacquered ash frame (opt.247SF), smoke glass

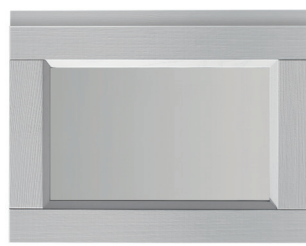

telaio frassino laccato grigio traffico a poro aperto (opz.244SF), vetro fumè  
open-pore traffic grey lacquered ash frame (opt.244SF), smoke glass



telaio frassino laccato verde fiordo a poro aperto (opz.2474F), vetro fumè  
open-pore fiordo green lacquered ash frame (opt.2474F), smoke glass

## presa maniglia handle grip

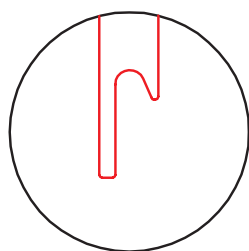
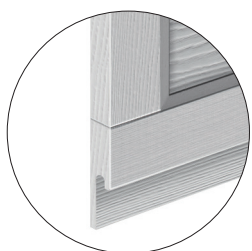

profilo tipo "A"  
type "A" profile

**SP. 22 MM TH.22 MM**

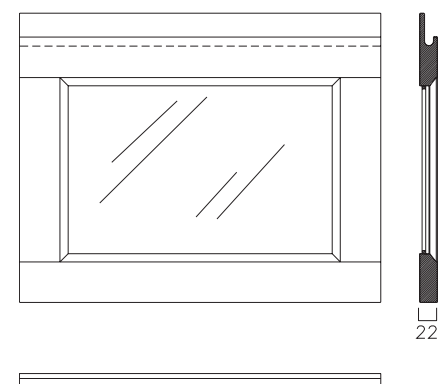

# selma

## strutture carcasses



bianco (opz.001)  
schiena e ripiano bianco  
(opz.001)  
white (opt.001)  
white back panel and shelf  
(opt.001)



conchiglia (opz.8910)  
schiena e ripiano conchiglia  
(opz.8910)  
shell (opt.8910)  
shell back panel and shelf  
(opt.8910)

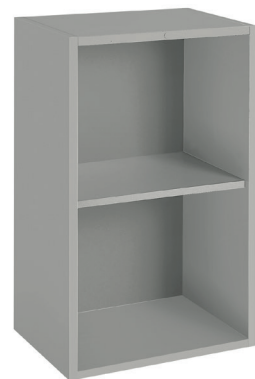

argilla (opz.9690)  
schiena e ripiano argilla  
(opz.9690)  
clay (opt.9690)  
clay back panel and shelf  
(opt.9690)



**GRUPPO LUBE ECOLOGIC**  
IL GRUPPO LUBE UTILIZZA  
PER I COMPONENTI DELLE CUCINE,  
MATERIALE CONFORME AL  
REGOLAMENTO EPA TSCA TITLE VI,  
UNO DEI PIU' SEVERI IN MERITO  
ALLE NORMATIVE DI  
SALVAGUARDIA AMBIENTALE.

\*per componenti si intendono tutte le strutture,  
alcune ante e alcuni complementi del modello.



**GREENGUARD**

PRODUCT CERTIFIED FOR  
LOW CHEMICAL EMISSIONS  
ULCOM/CG  
UL2818

**GREENGUARD**

LE STRUTTURE DELLE CUCINE  
SONO CONTRADDISTINTE  
DALLA CERTIFICAZIONE  
GREENGUARD PER  
SODDISFARE GLI STANDARD  
PIU' RIGOROSI IN TERMINI  
DI LIVELLI DI EMISSIONE  
DI COMPOSTI ORGANICI  
VOLATILI (COV).

## mensole in laminato laminate shelves



bianco (opz.001)  
white (opt.001)

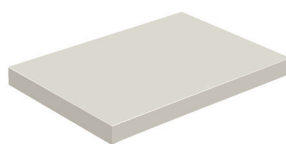

conchiglia (opz.8910)  
shell (opt.8910)

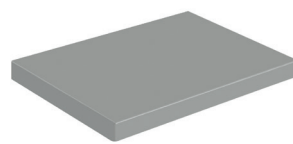

argilla (opz.9690)  
clay (opt.9690)

## mensole impialacciate veneered shelves



colori come ante (vedi pag.14)  
colours same as doors (see page 14)

# selma

---

## zoccoli in pvc H 13 pvc plinths H 13

di serie  
standard



frassino bianco  
(opz.2471)  
white ash (opt.2471)



alluminio satinato  
(opz.405)  
satin aluminium  
(opt.405)



frassino verde fiordo  
(opz.2474)  
fiordo green ash  
(opt.2474)

---

## zoccoli in alluminio H 13 aluminium plinths H 13



alluminio finitura titanio  
ossidato (opz.414)  
aluminium titanium  
oxidized finish (opt.414)

---

## zoccoli in alluminio H 13 verniciati a polvere finitura opaca aluminum plinths H 13 powder coated matt finish

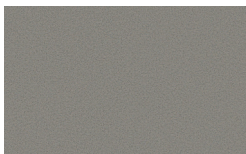

grigio selce (opz.SEL)  
flint grey (opt.SEL)



silver dark (opz.9507)  
dark silver (opt.9507)



grigio traffico (opz.9511)  
traffic grey (opt.9511)

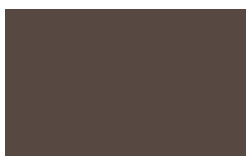

ghisa (opz.9509)  
cast iron (opt.9509)



lino (opz.9513)  
linen (opt.9513)





# MODULARITÀ E COMPONENTIBILITÀ MODULARITY AND FITTING SOLUTIONS

**BASI H 73**  
BASE UNITS H 73

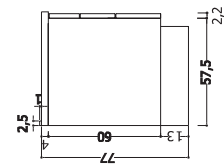

**BASI SOSPESE LIVING**  
HANGING LIVING BASE UNITS

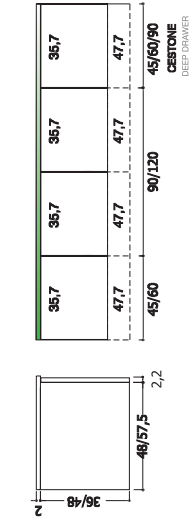

**BASI LIVING CON ZOCCOLO**  
ROOM UNITS WITH PLINTH

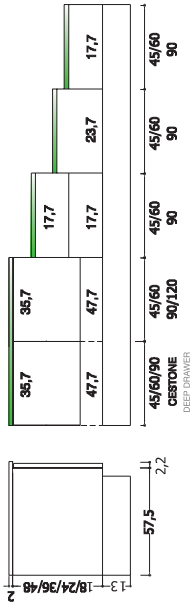

**COLONNE FRIGO**  
FRIDGE COLUMNS

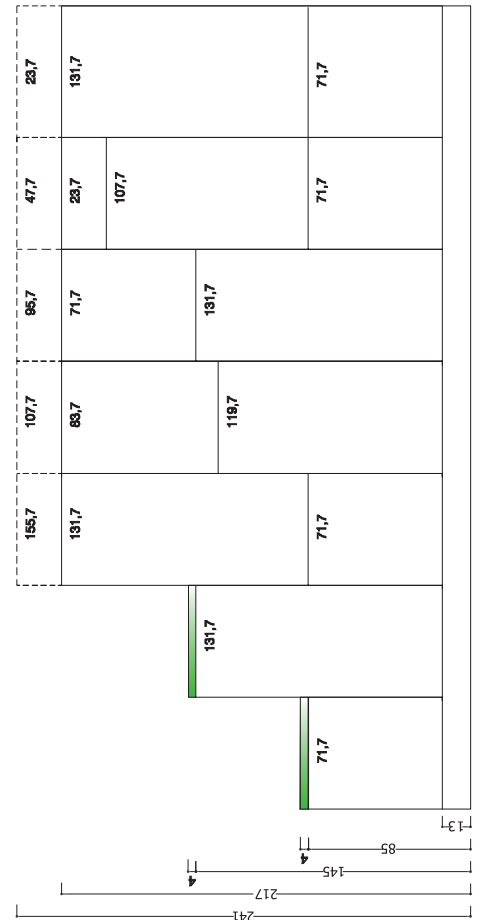
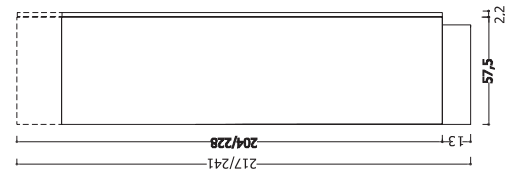

- 60 FRIGO CONG. SOTTOTOP UNDER TOP FRIDGE FREEZER
- 60 FRIGO LT 215 MONOPORTA SINGLE DOOR FRIDGE 215 L
- 60 FRIGO CONG. 1 MOTORE LT 315-380-380 FRIDGE FREEZER 315 L-380-380L
- 60 FRIGO LT 280 - LT 280 FRIDGE 280 L
- 60 FRIGO LT 215 FRIDGE 215 L
- 60 FRIGO CONG. LT. 315 3 ANTE FRIDGE CONG. 315 L THREE DOORS
- 75 FRIGO CONG. LT. 400 MONOPORTA FRIDGE FREEZER 400 L

**COLONNE FORNO**  
OVEN COLUMNS

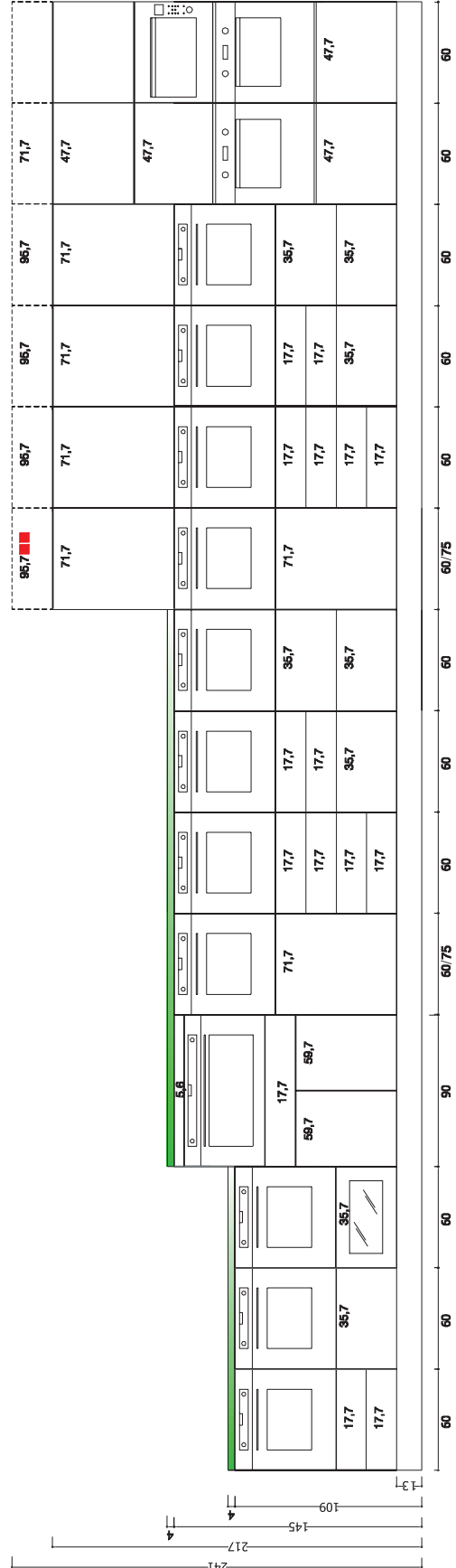
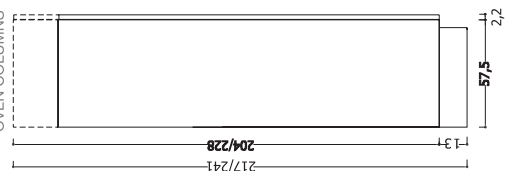

# PENSILI RIBALTA CHIUSURA AMMORTIZZATA

FLAP DOOR WALL UNITS BLUMOTION CLOSING SYSTEM

## PENSILE CON APERTURA A RIBALTA

Le ante aprendosi verso l'alto consentono di avere un' ampia visione d'insieme all'interno del mobile. In questo modo è possibile un comodo accesso agli oggetti contenuti al suo interno e, dal punto di vista ergonomico, molto vantaggioso. La regolazione della forza di apertura può essere impostata in modo esatto in base al peso del frontale. Grazie all'arresto progressivo le ante si fermano in qualsiasi posizione; in questo modo la maniglia è sempre facilmente raggiungibile. La chiusura è ammortizzata di serie.

### WALL UNIT WITH FLAP DOOR

The doors that open upwards guarantee ample overall visibility inside the cabinet. In this way, all objects housed inside the cabinet can be comfortably accessed, making the system highly advantageous from an ergonomic perspective. The opening force can be adjusted precisely according to the weight of the front. The doors stop in any position thanks to the gradual stopping movement; in this way, the handle is always easily accessible. The closing movement is cushioned standard

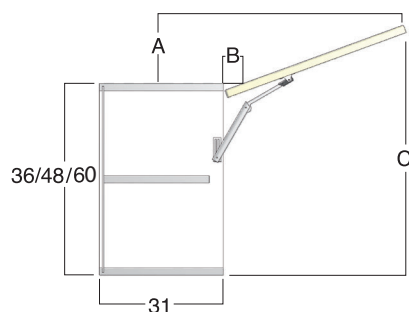

	A	B	C
H 36	10	2,3	46
H 48	13	2,3	61
H 60	17,2	2,3	77,2

**APERTURA VERTICALE OBLIQUA**

I pensili con questo tipo di meccanismo necessitano per l'apertura di poco spazio libero sopra il mobile grazie al movimento basculante dell'anta che si apre senza difficoltà applicando poca forza anche in presenza di frontali pesanti. Con l'arresto progressivo le ante si fermano in qualsiasi posizione; in questo modo la maniglia è sempre facilmente raggiungibile. La chiusura è ammortizzata ed è possibile regolare la forza di tenuta in base al peso del frontale.

VERTICAL OPENING OBLIQUE

Wall units that mount this type of mechanism require little clearance above the cabinet thanks to the swivelling movement of the door that can be easily opened by applying slight pressure, even with heavy fronts. The doors stop in any position thanks to the gradual stopping movement; in this way, the handle is always easily accessible. The closing movement is cushioned and the closing force can be adjusted according to the weight of the front door.

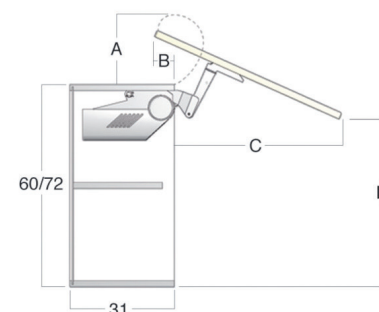

	A	B	C	D
H 60	18	9,6	46,5	53,5
H 72	18	9,6	57	61

**PENSILE CON APERTURA ANTE A PACCHETTO**

Il meccanismo d'apertura ante a pacchetto è idoneo sia sul pensile H 72 che H 96; la regolazione della forza di apertura può essere impostata in modo esatto in base ai pesi dei frontali, la chiusura è ammortizzata e la cerniera centrale clip si contraddistingue per l'innovativa tecnologia che garantisce la sicurezza per le dita.

WALL UNIT WITH LIFT-UP FOLDING DOORS

The lift-up folding door opening mechanism is suitable for wall units with H 72 or H 96; the opening force can be adjusted precisely according to the weight of the fronts, while the closing movement is cushioned and the central clip-on hinge features innovative technology for safeguarding the fingers.

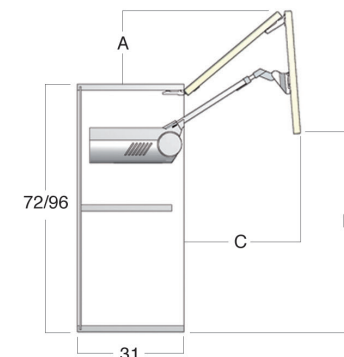

	A	B	C
H 72	19,5	54	41
H 96	24,7	69	53

**SCHEMA MONTAGGIO LIMITATORE**  
LIMITER INSTALLATION DIAGRAM

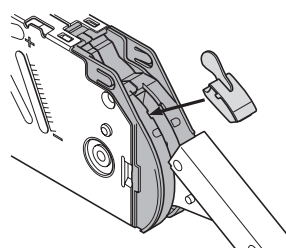
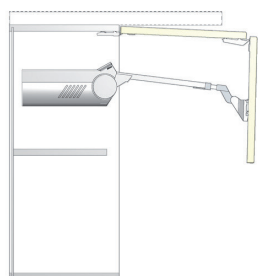

Per evitare l'interferenza dell'anta in fase di apertura con cornici o mensole, si può richiedere il limitatore dell'angolo di apertura cod. 5620005

In order to avoid that the door interferes with cornices or shelves during the opening movement, it is possible to request an opening angle limiter: code 5620005

## COMPOSIZIONE BASSA L 255

LOW COMPOSITION W 255



## COMPOSIZIONE BASSA L 300

LOW COMPOSITION W 300



## COMPOSIZIONE BASSA L 255

LOW COMPOSITION W 255

### COMPONENTI COMPONENTS

**Colonna 60 H 217 frigo-freezer 230 classe A+**

60 cm column H 217 fridge-freezer 230 class "A+"

**Base 45 2 cassetti e cestone**

45 cm base unit with 2 drawers and deep drawer

**Base 60 forno statico inox con ventilazione tangenziale di raffreddamento**

stainless steel static oven with orbital cooling ventilation 60 base unit

**Piano cottura 60 4 gas inox con valvola di sicurezza**

60 cm stainless steel hob with 4 gas burners with safety valve

**Sottolavello 90**

90 cm sink unit

**Lavello ad incasso 86 x 50 1 vasca inox prelucidato**

86x50 cm built-in sink with 1 stainless steel bowl

**Pensile vetro 45 H 72**

45 cm glass wall unit H 72

**Cappa 60 aspirante estraibile H 63 1 motore**

60 cm hood slide-out ducting H 63 1 motor

**Scolapiatti 90 H 72**

90 cm plate rack H 72

**Top 195 P 61 in laminato H 4**

195 cm laminate worktop D 61 H 4

**Asta appendipensili ml 2**

2 lm wall unit fixing strip

**(Elettrodomestici Indesit )**  
(Indesit appliances)

**SELMA**

## COMPOSIZIONE BASSA L 300

LOW COMPOSITION W 300

### COMPONENTI COMPONENTS

**Colonna 60 H 217 frigo-freezer 230 classe A+**

60 cm column H 217 fridge-freezer 230 class "A+"

**Base 60 2 cassetti e cestone**

60 cm base unit with 2 drawers and deep drawer

**Base 60 forno statico inox con ventilazione tangenziale di raffreddamento**

stainless steel static oven with orbital cooling ventilation 60 base unit

**Piano cottura 60 4 gas inox con valvola di sicurezza**

60 cm stainless steel hob with 4 gas burners with safety valve

**Base 60**

60 cm base unit

**Sottolavello 60**

60 cm sink unit

**Lavello ad incasso 86 x 50 1 vasca inox prelucidato**

86x50 cm built-in sink with 1 stainless steel bowl

**Pensile 60 H 72**

60 cm wall unit H 72

**Cappa 60 aspirante estraibile H 63 1 motore**

60 cm hood slide-out ducting H 63 1 motor

**Pensile 60 H 72**

60 cm wall unit H 72

**Scolapiatti 60 H 72**

60 cm plate rack H 72

**Top 240 P 61 in laminato H 4**

240 cm laminate worktop D 61 H 4

**Asta appendipensili ml 4**

4 lm wall unit fixing strip

**(Elettrodomestici Indesit )**  
(Indesit appliances)

**SELMA**

## COMPOSIZIONE ALTA L 300

HIGH COMPOSITION W 300



## COMPOSIZIONE BASSA L 360

LOW COMPOSITION W 360



## COMPOSIZIONE ALTA L 300

HIGH COMPOSITION W 300

### COMPONENTI COMPONENTS

#### Colonna 60 H 241 frigo-freezer 230 classe A+

60 cm column H 241 fridge-freezer 230 class "A+"

#### Base 60 2 cassetti e cestone

60 cm base unit with 2 drawers and deep drawer

#### Base 60 forno statico inox con ventilazione tangenziale di raffreddamento

stainless steel static oven with orbital cooling ventilation 60 base unit

#### Piano cottura 60 4 gas inox con valvola di sicurezza

60 cm stainless steel hob with 4 gas burners with safety valve

#### Base 60

60 cm base unit

#### Sottolavello 60

60 cm sink unit

#### Lavello ad incasso 86 x 50 1 vasca inox prelucidato

86x50 cm built-in sink with 1 stainless steel bowl

#### Pensile 60 H 72

60 cm wall unit H 72

#### Cappa 60 aspirante estraibile H 63 1 motore

60 cm hood slide-out ducting H 63 1 motor

#### Pensile 60 H 96

60 cm wall unit H 96

#### Scolapiatti 60 H 96

60 cm plate rack H 96

#### Top 240 P 61 in laminato H 4

240 cm laminate worktop D 61 H 4

#### Mensola 120 P 31 sp. 3,8

120 cm shelf D 31 sp. 3,8

#### Asta appendipensili ml 4

4 lm wall unit fixing strip

(Elettrodomestici Indesit )  
(Indesit appliances)

SELMA

## COMPOSIZIONE BASSA L 360

LOW COMPOSITION W 360

### COMPONENTI COMPONENTS

#### Colonna 60 H 217 frigo-freezer 230 classe A+

60 cm column H 217 fridge-freezer 230 class "A+"

#### Colonna 60 H 109 con cestone, forno statico inox con ventilazione tangenziale di raffreddamento

60 column H.109 with deep drawer configured for stainless steel static oven with orbital cooling ventilation

#### Base 90 2 cassetti + cestone predisposto P.C.

90 cm base unit with 2 drawers + deep drawer configured for hob

#### Piano cottura 60 4 gas inox con valvola di sicurezza

60 cm stainless steel hob with 4 gas burners with safety valve

#### Base 60

60 cm base unit

#### Sottolavello 90

90 cm sink unit

#### Lavello ad incasso 86 x 50 1 vasca inox prelucidato

86x50 cm built-in sink with 1 stainless steel bowl

#### Pensile 60 H 72

60 cm wall unit H 72

#### Cappa 90 sempione acciaio inox satinato + vetro

90 cm sempione hood brushed stainless steel + glass

#### Pensile 60 H 72

60 cm wall unit H 72

#### Scolapiatti 90 H 72

90 cm plate rack H 72

#### Top 240 P 61 in laminato H 4

240 cm laminate worktop D 61 H 4

#### Top 60 P 61 in laminato H 4

60 cm laminate worktop D 61 H 4

#### Asta appendipensili ml 4

4 lm wall unit fixing strip

(Elettrodomestici Indesit )  
(Indesit appliances)

SELMA